

Item description/product images

**Description**

Material:
Aluminium alloy.

Version:
anodised.

Note:
The mounting plate is used for the vertical mounting of the short or long positioning stages with electric drive. With slots for direct support of inductive proximity switch (20905-005). The proximity switch can be adjusted when the positioning unit is mounted. The threaded holes M4 are used to fasten the sensor holder 21093.

Can be combined with all other parts of the same size.

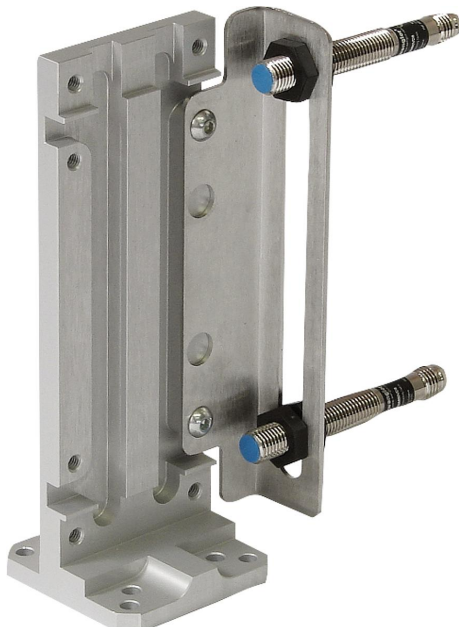
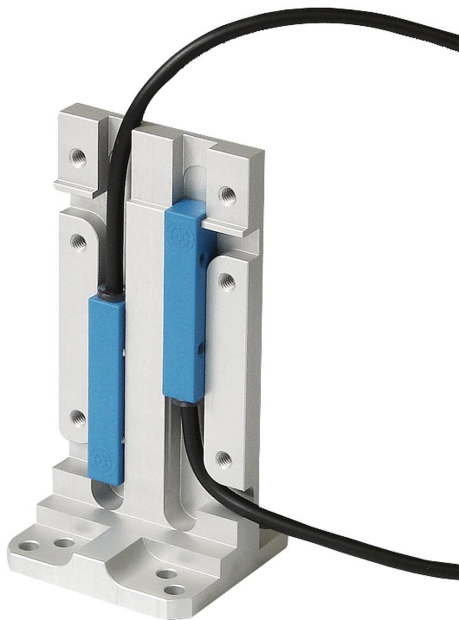

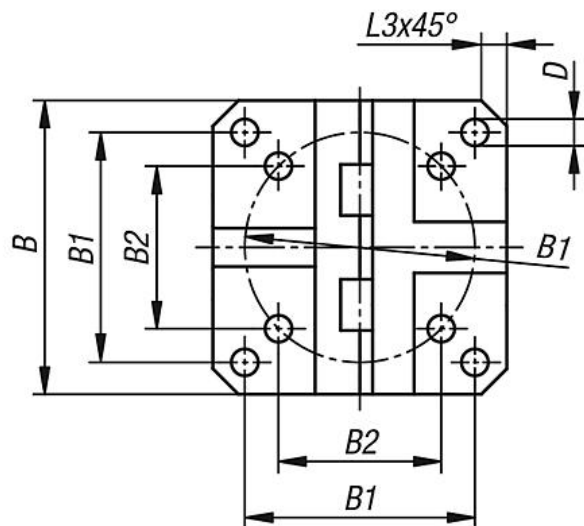
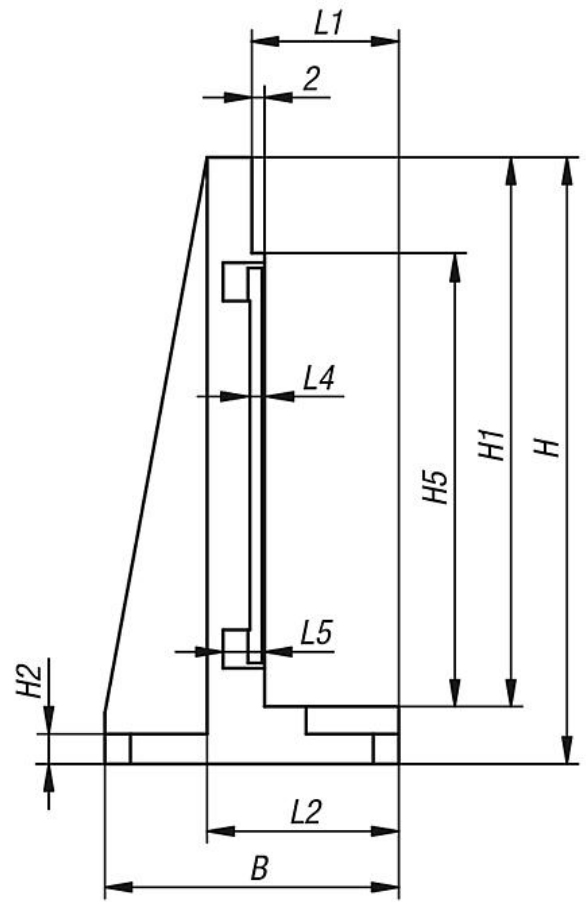
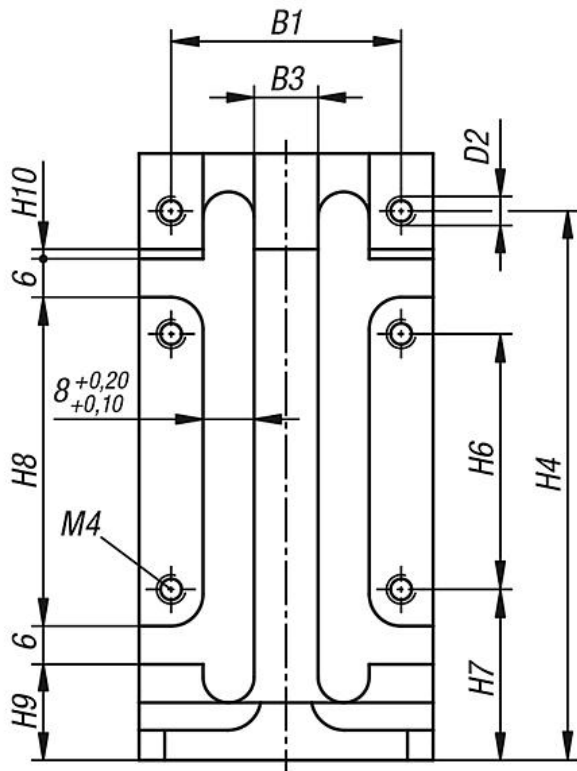

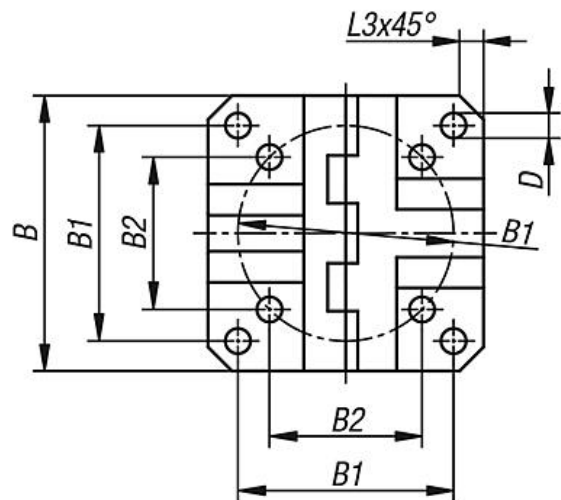
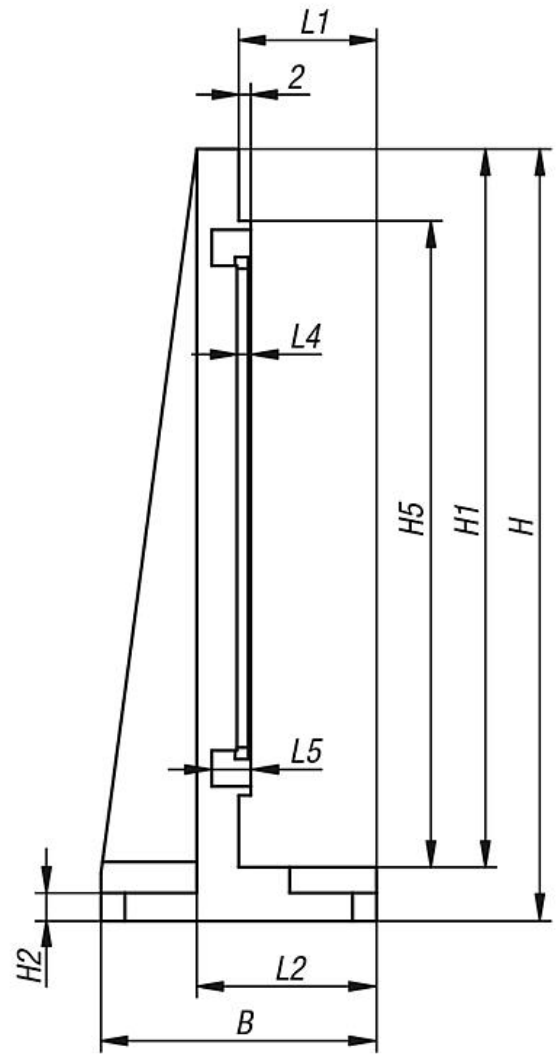
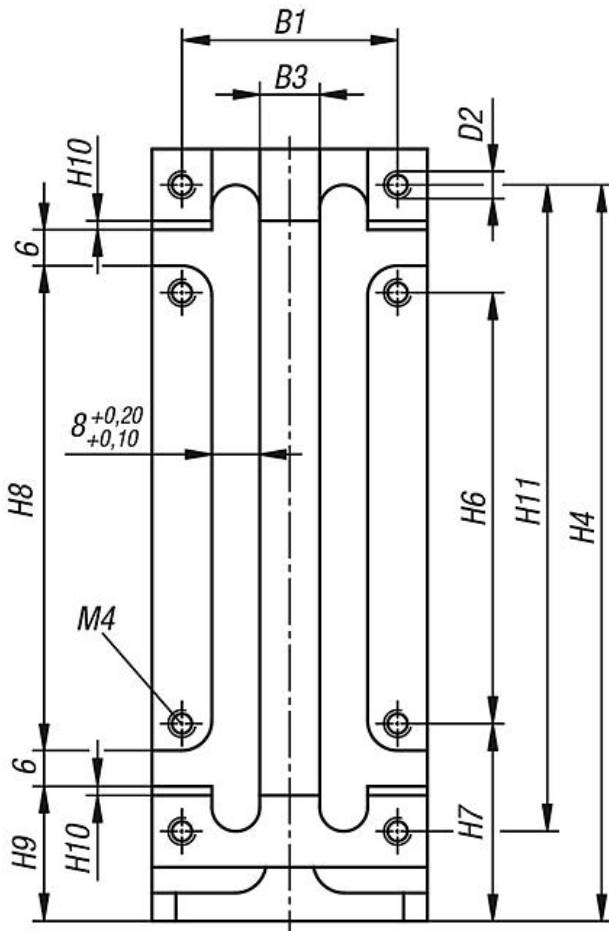

Overview of items

Order No.	Size	Version	B	B1	B2	B3	D	D2	H	H1	H2	H4	H5	H6	H7	H8	H9	H10	L1	L2	L3	L4	L5
21091-081	8	short	46	36	25,5	10	4,2	M4	95	86	4,7	86	71	40	26,75	51,5	15	1,5	23	30	4	2,3	6,5
21091-121	12	short	75	60	42,4	30	6,4	M6	146	136	5,7	131	106	60	35,5	83	18	3	27	36	7	3,3	7,5

Order No.	Size	Version	B	B1	B2	B3	D	D2	H	H1	H2	H4	H5	H6	H7	H8	H9	H10	H11	L1	L2	L3	L4	L5
21091-082	8	long	46	36	25,5	10	4,2	M4	129	120	4,7	123	108	72	33	81	22,9	1,5	108	23	30	4	2,3	6,5
21091-122	12	long	75	60	42,4	30	6,4	M6	192	180	5,7	184,5	177	120	42	132	30	3	165	27	36	7	3,3	7,5