

# Technical information for O-rings

## Seal effect

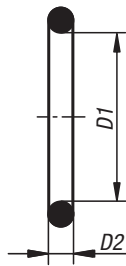
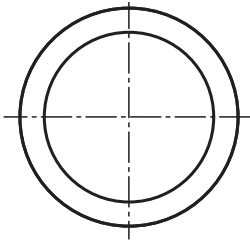

An O-ring is a sealing element used to reliably seal against fluids and gases. The seal effect is created during installation by axial or radial compression of the cross-section. During operation, the pressure of the medium intensifies the deformation of the O-ring and enhances the sealing function.

An O-ring is used primarily for static seals. They have only limited use as dynamic seals in hydraulics and pneumatics (dependent on the pressure, speed and temperature). Due to frictional resistance, the compression for dynamic use should always be calculated less than for static applications. Sufficient lubrication should always be ensured during dynamic applications.

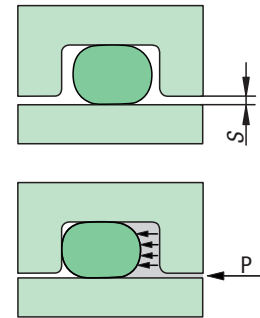

## Installation types

	Flange seal, axial installation, static sealing	With internal pressure: O-ring OD $(D1 + 2 \times D2)$ ca. 2% larger than slot OD $D5$ $D1 \sim D5 \times 1.02 - 2 \times D2$
	Flange seal, axial installation, static sealing	With external pressure: O-ring diameter $D1$ ca. 2% smaller than slot ID $D6$ $D1 \sim D6 \times 0.98$
	Shaft seal (internal sealing), radial installation, static/dynamic sealing	For internal sealing: O-ring diameter $D1 = D4$
	Piston seal (external sealing), radial installation, static/dynamic sealing	For external sealing: O-ring diameter $D1 \leq D3$
<p>Furthermore, there are additional installation types such as the trapezoidal slot and triangular slot. As it is difficult and expensive to manufacture a trapezoidal or triangular slot, installation in a square slot is preferred.</p>		

## Gap dimensions

Pressure forces the O-ring against the opposing face. The sealing gap should be kept as small as possible to prevent the O-ring being forced into it. A sealing gap that is too big can lead to gap extrusion and destruction of the O-ring.

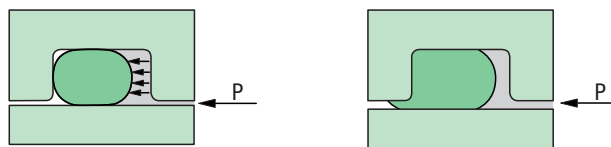

The reference values given in the table for gap dimensions for standard elastomer are maximum values based on central alignment of the components. The permissible values for the sealing gap are dependent on pressure, material hardness and diameter. All specifications are based on experience and should only be regarded as guideline values.

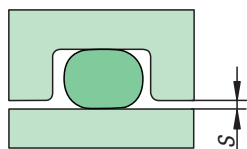

O-ring hardness Shore 70A					
Cord size D2	≤ 2	≤ 3	≤ 5	≤ 7	> 7
Pressure (bar)	Clearance S (mm)				
≤ 3,5	0,08	0,09	0,1	0,13	0,15
≤ 7,0	0,05	0,07	0,08	0,09	0,1
≤ 10	0,03	0,04	0,05	0,07	0,08

## Slot radii

The internal and external edges must not be sharp. All edges coming into contact with the O-ring must be completely deburred and rounded. The radii based on the cord size must be observed. Angled slot flanks of up to ca. 5° are permitted.

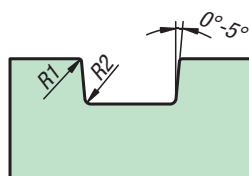

Cord size D2	R1	R2
< 2	0,1	0,3
< 3	0,2	0,3
< 4	0,2	0,5
< 5	0,2	0,6
< 6	0,2	0,6
< 8	0,2	0,8
> 8	0,2	1

## Lead-in chamfer

To prevent damage to the O-ring and to facilitate correct assembly, components should have lead-in chamfers.

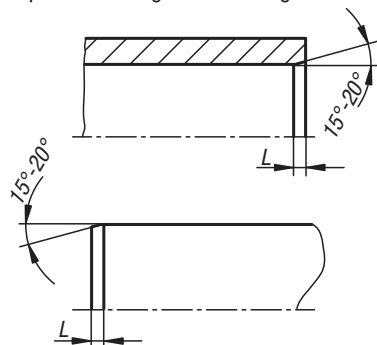

Cord size D2	L (15°)	L (20°)
≤ 1,80	2,5	2
≤ 2,65	3	2,5
≤ 3,55	3,5	3
≤ 5,30	4	3,5
≤ 7,00	5	4
> 7,00	6	4,5

## Surface finishes

The contact faces must fulfil a minimum quality to achieve an optimum sealing effect. The surface finish requirements depend mainly on the specific application. For dynamic sealing application or pulsating pressures, the surface finish must be finer than for static applications. The specified values cover the majority of sealing applications and are to be regarded as recommendations only.

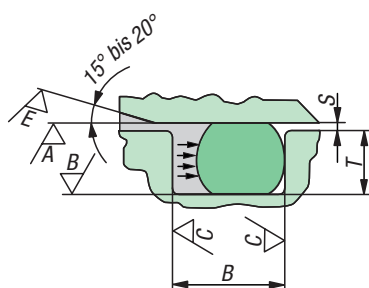

Face	Applications	Rz (µm)	Ra (µm)
Seal face A	Static	≤ 6,3	≤ 1,6
Slot base B	Static	≤ 6,3	≤ 1,6
Slot flanks C	Static	≤ 6,3	≤ 1,6
Seal face A	Dynamic	≤ 1,6	≤ 0,4
Slot base B	Dynamic	≤ 6,3	≤ 1,6
Slot flanks C	Dynamic	≤ 6,3	≤ 1,6
Lead-in chamfer E	-	≤ 6,3	≤ 1,6

## Assembly instructions

To ensure that the O-ring can fulfil its designated sealing function, any damage to the O-ring must be avoided during installation. The following installation instructions must be observed:

- Observe the defined lead-in chamfers and the required surface finishes
- All edges over which the O-ring passes must be deburred and rounded
- Any dirt, swarf or other particles must be removed from the insertion area and the groove
- Use installation aids (sleeves) to pass over threads and unavoidable sharp edges and corners
- Where possible, use oil or grease for installation (observe resistance)
- Do not use any sharp-edged installation tools or equipment
- Due to possible hardening, adhesives should never be used on O-rings
- Do not twist or distort the O-rings during installation
- Temporary stretching of the O-ring by 20% relative to the internal diameter is permissible for installation

## Dimensioning and selection of O-rings

For the optimum seal effect, O-rings with the largest possible cord size should be selected. Especially by unfavourable tolerances, the next largest cord size must be selected.

The seal effect of the O-ring is achieved by compressing it. Depending on the application, the following values should be achieved:

- static seal 15 – 30%
- dynamic seal 10 – 18% (hydraulics)
- dynamic seal 4 – 12% (pneumatics)

The adjacent table lists a recommendation for the O-ring compression depending on the cord diameter D2 and the application.

When installed, the O-ring should be

- stretched by max. 6%
- compressed by max. 3% relative to the inside diameter

O-ring cord size	Compression		
	Insert		
D2	Static hydr./pneum.	Dynamic hydraulic	Dynamic pneumatic
1,78	11,5 - 28,5 %	10,5 - 25,0 %	5,0 - 18,5 %
2	11,0 - 27,5 %	10,0 - 23,5 %	4,5 - 17,5 %
2,62	10,5 - 25,0 %	9,0 - 20,5 %	4,0 - 15,5 %
3	10,3 - 24,0 %	8,8 - 20,0 %	3,5 - 15,0 %
3,53	10,0 - 23,0 %	8,0 - 18,5 %	3,0 - 14,0 %
4	10,0 - 22,0 %	7,5 - 18,0 %	3,0 - 13,7 %
5	10,0 - 21,5 %	7,0 - 17,5 %	3,0 - 13,5 %
5,33	10,0 - 20,0 %	7,0 - 17,0 %	3,0 - 13,2 %
6	9,8 - 19,5 %	7,0 - 16,5 %	3,0 - 13,0 %
7	9,5 - 19,0 %	6,5 - 16,0 %	3,0 - 12,7 %
8	9,5 - 19,0 %	6,5 - 16,0 %	3,0 - 12,0 %

## Square groove dimensions

The values and tolerances specified in the table apply to NBR Shore 70A O-rings. Generally, these values can be adopted for other materials and material hardnesses, the groove depth may have to be adjusted. The specified values cover the majority of sealing applications and are to be regarded as recommendations only.

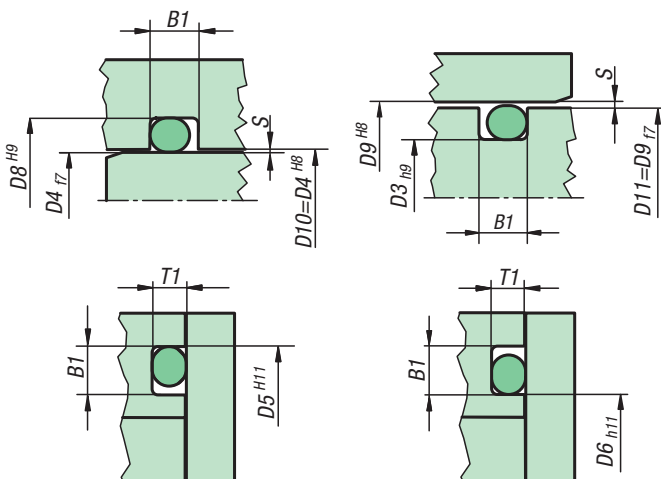

Example	
Shaft D4 = 58	D4 = 58
Radial installation, static (internal sealing)	
O-ring selection	D1 = 58, D2 = 3.5
Installation dimensions from table	
Slot base diameter D8	D8 = D4 + 5,3 = 63,3
Slot width B1	B1 = 4,6
Gap width G	
Diameter D10	D10 = D4 H8 = 58 <sup>0</sup> / 58 <sup>+46</sup>
Diameter D4	D4 f7 = 58 <sub>-30</sub> / 58 <sub>-60</sub>
Maximum gap G	S = 0.053

Assembly dimensions table

Installation dimensions							
O-ring cord size	Radial installationSlot base diameter				Slot width	Axial installation	
	Dynamic	Static	Dynamic	Static		Slot depth	Radius
D2	D3h9	D3h9	D8H9	D8H9	B1 +0,2	T1 +0,05	R2
0,5	-	D9-0,7	-	D4+0,7	0,8	0,35	0,2
0,74	-	D9-1,0	-	D4+1,0	1	0,5	0,2
1,00 1,02	-	D9-1,4	-	D4+1,4	1,4	0,7	0,2
1,2	-	D9-1,7	-	D4+1,7	1,7	0,85	0,2
1,25 1,27	-	D9-1,8	-	D4+1,8	1,7	0,9	0,2
1,3	-	D9-1,9	-	D4+1,9	1,8	0,95	0,2
1,42	-	D9-2,1	-	D4+2,1	1,9	1,05	0,3
1,50 1,52	D9-2,5	D9-2,2	D4+2,5	D4+2,2	2	1,1	0,3
1,60 1,63	D9-2,6	D9-2,4	D4+2,6	D4+2,4	2,1	1,2	0,3
1,78 1,80	D9-2,9	D9-2,6	D4+2,9	D4+2,6	2,4	1,3	0,4
1,83	D9-3,0	D9-2,7	D4+3,0	D4+2,7	2,5	1,35	0,4
1,9	D9-3,1	D9-2,8	D4+3,1	D4+2,8	2,6	1,4	0,4
1,98 2,00	D9-3,3	D9-3,0	D4+3,3	D4+3,0	2,7	1,5	0,4
2,08 2,10	D9-3,5	D9-3,1	D4+3,5	D4+3,1	2,8	1,55	0,4
2,2	D9-3,7	D9-3,2	D4+3,7	D4+3,2	3	1,6	0,4
2,26	D9-3,8	D9-3,4	D4+3,8	D4+3,4	3	1,7	0,4
2,30 2,34	D9-3,9	D9-3,5	D4+3,9	D4+3,5	3,1	1,75	0,4
2,4	D9-4,1	D9-3,6	D4+4,1	D4+3,6	3,2	1,8	0,5
2,46	D9-4,2	D9-3,7	D4+4,2	D4+3,7	3,3	1,85	0,5
2,5	D9-4,3	D9-3,7	D4+4,3	D4+3,7	3,3	1,85	0,5
2,62 2,65	D9-4,5	D9-4,0	D4+4,5	D4+4,0	3,6	2	0,6
2,7	D9-4,6	D9-4,1	D4+4,6	D4+4,1	3,6	2,05	0,6
2,8	D9-4,8	D9-4,2	D4+4,8	D4+4,2	3,7	2,1	0,6
2,92 2,95	D9-5,0	D9-4,4	D4+5,0	D4+4,4	3,9	2,2	0,6
3	D9-5,2	D9-4,6	D4+5,2	D4+4,6	4	2,3	0,6
3,1	D9-5,4	D9-4,8	D4+5,4	D4+4,8	4,1	2,4	0,6
3,5	D9-6,1	D9-5,3	D4+6,1	D4+5,3	4,6	2,65	0,6
3,53 3,55	D9-6,2	D9-5,4	D4+6,2	D4+5,4	4,8	2,7	0,8
3,6	D9-6,3	D9-5,6	D4+6,3	D4+5,6	4,8	2,8	0,8
4	D9-7,0	D9-6,2	D4+7,0	D4+6,2	5,2	3,1	0,8
4,5	D9-8,0	D9-7,0	D4+8,0	D4+7,0	5,8	3,5	0,8
5	D9-8,8	D9-8,0	D4+8,8	D4+8,0	6,6	4	0,8
5,30 5,33	D9-9,4	D9-8,6	D4+9,4	D4+8,6	7,1	4,3	1,2
5,5	D9-9,6	D9-9,0	D4+9,6	D4+9,0	7,1	4,5	1,2
5,7	D9-10,0	D9-9,2	D4+10,0	D4+9,2	7,2	4,6	1,2
6	D9-10,6	D9-9,8	D4+10,6	D4+9,8	7,4	4,9	1,2
6,5	D9-11,4	D9-10,8	D4+11,4	D4+10,8	8	5,4	1,2
6,99 7,00	D9-12,2	D9-11,6	D4+12,2	D4+11,6	9,5	5,8	1,5
7,5	D9-13,2	D9-12,6	D4+13,2	D4+12,6	9,7	6,3	1,5
8	D9-14,2	D9-13,4	D4+14,2	D4+13,4	9,8	6,7	1,5
8,4	D9-15,0	D9-14,2	D4+15,0	D4+14,2	10	7,1	1,5
9	D9-16,2	D9-15,4	D4+16,2	D4+15,4	10,6	7,7	2
9,5	D9-17,2	D9-16,4	D4+17,2	D4+16,4	11	8,2	2
10	D9-18,2	D9-17,2	D4+18,2	D4+17,2	11,6	8,6	2,5
12	D9-22,0	D9-21,2	D4+22,0	D4+21,2	13,5	10,6	2,5

## Crush groove dimensions

Used by flange and cover sealing. In this type of groove the O-ring has contact to three faces. No defined compression of the O-ring is guaranteed. This groove type also permits very little swelling of the O-ring. Observation of the dimensions and tolerances given in the adjacent table are important for the sealing function. The O-ring cord size D2 should be greater than 3 mm.

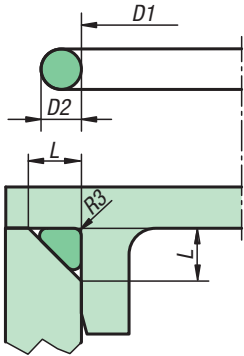

O-ring cord size D2	Edge length L	Radius R3
1,78 1,80	2,4 +0,10	0,3
2	2,7 +0,10	0,4
2,4	3,2 +0,15	0,4
2,5	3,4 +0,15	0,6
2,62 2,65	3,5 +0,15	0,6
3	4,0 +0,20	0,6
3,1	4,1 +0,20	0,6
3,53 3,55	4,7 +0,20	0,9
4	5,4 +0,20	1,2
5	6,7 +0,25	1,2
5,30 5,33	7,1 +0,25	1,5
5,7	7,6 +0,25	1,5
6	8,0 +0,30	1,5
7	9,4 +0,30	2

## Dovetail groove dimensions

With the trapezoidal slot, the O-ring is secured in the slot. Due to the method used to machine the slot, this application is only recommended from a cord size D2 of ca. 2.5 mm. The slot width B2 is measured before the edges are deburred. The average slot diameter is  $D7 = D1 + D2$ .

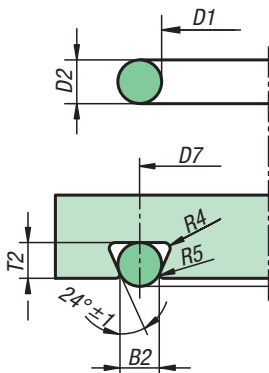

O-ring cord size D2	Slot width B2 +/- 0,05	Slot depth T2 +/- 0,05	Radius R4	Radius R5
2,5	2,05	2	0,4	0,25
2,62 2,65	2,15	2,1	0,4	0,25
3	2,4	2,4	0,4	0,25
3,1	2,4	2,4	0,4	0,25
3,53 3,55	2,9	2,9	0,8	0,25
4	3,1	3,2	0,8	0,25
5	3,9	4,2	0,8	0,25
5,30 5,33	4,1	4,6	0,8	0,4
5,7	4,4	4,8	0,8	0,4
7	5,6	6	1,6	0,4
8	6	6,9	1,6	0,4
8,4	6,3	7,3	1,6	0,4