

Item description/product images



Description

Material:

Housing, steel.
Magnetic core hard ferrite.

Version:

Housing, electro zinc-plated.

Note:

Shielded system.

Temperature range:

max. 200°C.

Drawing reference:

1) magnetic face

Drawings

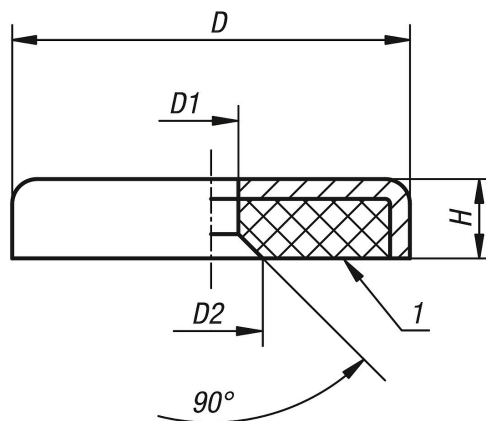

Overview of items

Order No.	D	D1	D2	H	Magnetic force N
09071-01	16±0,15	3,5 ±0,2	7,5±1	4,5	14
09071-02	20±0,15	4,2±0,2	8,5±1	6	22
09071-03	25±0,15	5,5±0,2	12±1	7	36
09071-04	32±0,20	5,5±0,2	12±1	7	72
09071-05	40±0,20	5,5±0,2	13±1	8	90