

Item description/product images



Description

Material:

Black thermoset PF 31.

Bush and screw electro zinc-plated steel or bright stainless steel.

Version:

High-gloss polished.

On request:

Other screw sizes, screw lengths and colours.

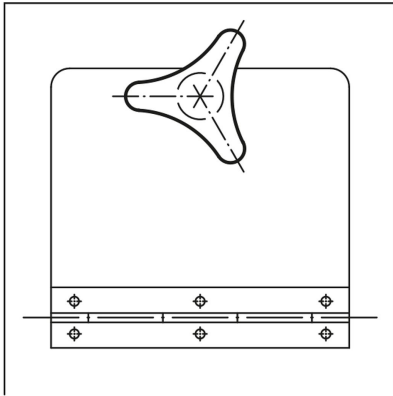

Drawings

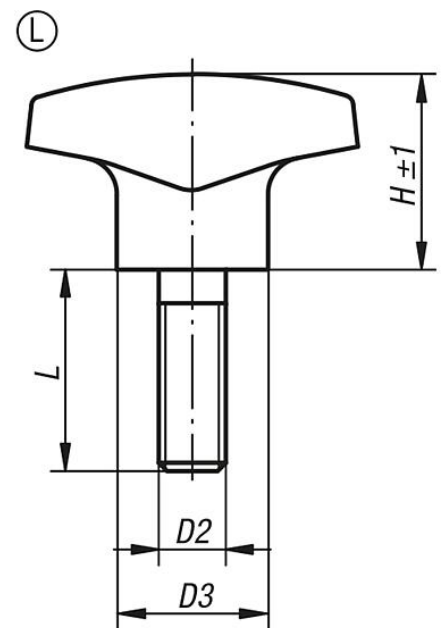
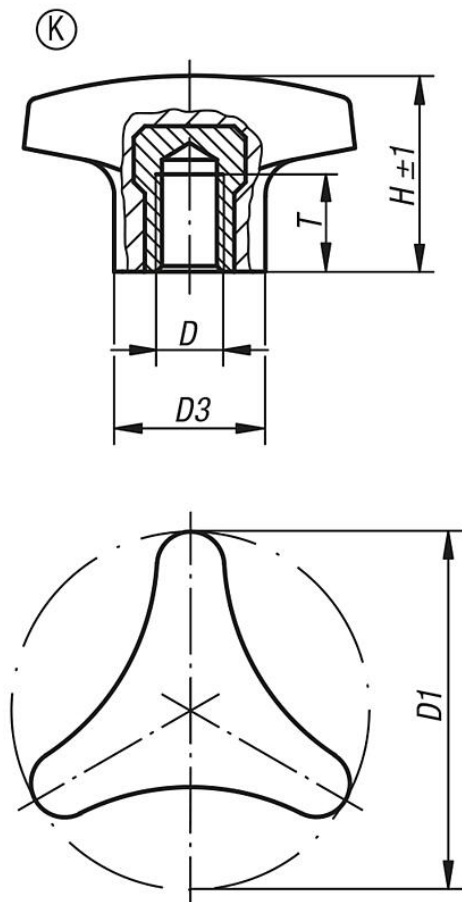

Overview of items

Overview of items

Triangular grips with high collar, internal thread

Order No.	Form	Component material	D	D1	D3	H	T
06702-14006	K	steel	M6	40	16	22	12
06702-15008	K	steel	M8	50	18	28	14
06702-16210	K	steel	M10	62	22	35	14
06702-24006	K	stainless steel	M6	40	16	22	9
06702-25008	K	stainless steel	M8	50	18	28	13
06702-26210	K	stainless steel	M10	62	22	35	13

Triangular grips with high collar, external thread

Order No.	Form	Component material	D	D1	D3	H	L
06702-14006X15	L	steel	M6	40	16	22	15
06702-14008X20	L	steel	M8	40	16	22	20
06702-15008X20	L	steel	M8	50	18	28	20
06702-15010X25	L	steel	M10	50	22	28	25
06702-16210X25	L	steel	M10	62	22	35	25
06702-24006X20	L	stainless steel	M6	40	12	22	20
06702-24008X20	L	stainless steel	M8	40	16	22	20
06702-25008X20	L	stainless steel	M8	50	18	28	20
06702-25010X30	L	stainless steel	M10	50	18	28	30
06702-26210X30	L	stainless steel	M10	62	22	35	30