

Item description/product images



Description

Material:

Housing aluminium.

Measuring spindle stainless steel.

Version:

Measuring spindle hardened and ground.

Note:

Display rotatable by 280°

Standard holding shank Ø 8h6

Exchangeable probe

Thread M2.5

Protection class IP42

Function:

– Measures in mm or inch

– Preset

Switch-off electronics.

6 digit LCD display.

Extra large digits.

Digit height 8.5 mm.

Max. transverse speed 1.5 m/s.

interface Opto RS232C.

Battery life ca. 2000 hours.

Supplied with CR2032 battery.

Accessory:

Spare CR2032 battery

order No. 32510-20.

Drawings

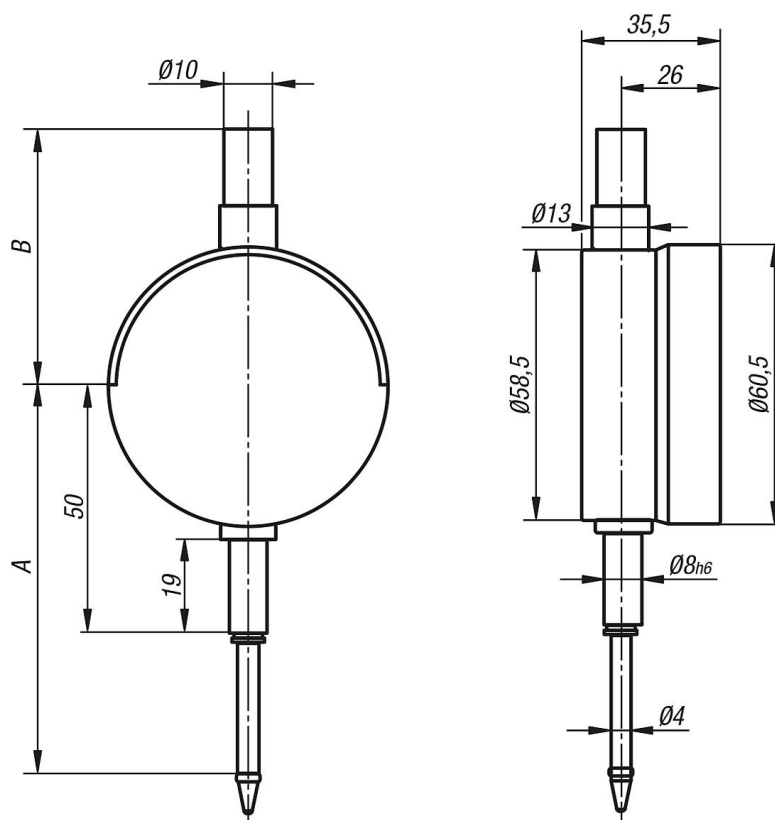

Overview of items

Order No.	Version	Type	A	B	Measuring range mm	Resolution mm	Precision mm	Repeat precision μm	Probe force N
32542-01	dial gauge	Preset	78,4	53,4	25	0,001	0,005	2 ($\pm 2\text{s}$)	0,6 - 1,10
32542-02	dial gauge	Preset	78,4	53,4	25	0,01	0,010	2 ($\pm 2\text{s}$)	0,6 - 1,10
32542-03	dial gauge	Preset	65,9	53,4	12,5	0,001	0,005	2 ($\pm 2\text{s}$)	0,7 - 0,95
32542-04	dial gauge	Preset	65,9	53,4	12,5	0,01	0,010	2 ($\pm 2\text{s}$)	0,65 - 0,9
32542-012	dial gauge with calibration certificate	Preset	78,4	53,4	25	0,001	0,005	2 ($\pm 2\text{s}$)	0,6 - 1,10
32542-022	dial gauge with calibration certificate	Preset	78,4	53,4	25	0,01	0,010	2 ($\pm 2\text{s}$)	0,6 - 1,10
32542-032	dial gauge with calibration certificate	Preset	65,9	53,4	12,5	0,001	0,005	2 ($\pm 2\text{s}$)	0,7 - 0,95
32542-042	dial gauge with calibration certificate	Preset	65,9	53,4	12,5	0,01	0,010	2 ($\pm 2\text{s}$)	0,65 - 0,9