

Item description/product images



Description

Material:

Thermoplastic, graphite black.
Bush brass or threaded pins steel 5.8.

Version:

Screw blue passivated.

Application:

Sensitive electrical or electronic equipment, components and devices (ESD sensitive elements) may be damaged or destroyed by electrostatic discharges (ESD) in the immediate vicinity.

Electrostatic discharges can come from people or through handling ESD sensitive components (e.g. during production, assembly, transport, storage etc).

Electrically conductive products which conform to DIN EN 61340-5-1 are essential within electronic environments to prevent an electrostatic discharge.

These products can be used for ESD applications or in ESD protection areas (EPA) in accordance with DIN EN 61340-5-1.

Safety:

These ESD products can also be used for devices, components and protection systems in areas with high risk of explosion.

Use of these ESD products prevents the occurrence of electrostatic spark discharges, eliminating the potential ignition of gases and dusts which could lead to explosions in enclosed spaces.

Manufacturers and operators must use and conform to ATEX directives for the protection of persons working in areas with high risk of explosion.

These ESD products are certified by TÜV-Süd in relation to their electrical discharge capability.

Target groups:

Device manufacturers required to conform to ATEX product directive 2014/34/EU.

Operators required to conform to ATEX worker protection directive 1999/92/EC.

Drawings

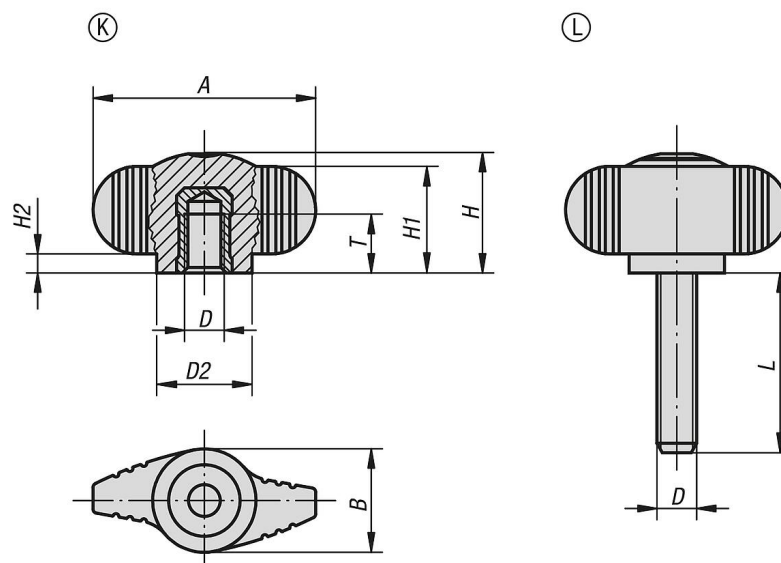

Overview of items

Order No.	Form	Main colour	A	B	D	D2	H	H1	H2	L	T
06652-1100624	K	graphite black RAL 9011	28	13	M6	12	15	13,3	2,3	-	9
06652-1100624X15	L	graphite black RAL 9011	28	13	M6	12	15	13,3	2,3	15	-