

Item description/product images

**Description****Material:**

Metal parts, steel grade 5.6.
Elastomer, natural rubber,
medium hardness, Shore 60.

Version:

Steel electro zinc-plated.

Note:

These machine feet have proven themselves to be universally applicable elements for the elastic support of all types of machine. They are commonly used wherever large horizontal movements are to be avoided. The horizontal rigidity is higher in all directions than the vertical rigidity. If used correctly they are excellent at preventing the transfer of vibration and noise.

Machine feet with shear protection are available for situations where tensile forces are to be expected.

The indicated load data are reference values for static loads by rubber hardness of Shore 60A.

In contrast to those in the drawing, the holes D2 can also be elongated holes.

On request:

Rubber hardness Shore 40 or 70 A.

Drawing reference:

1) With shear protection

Drawings

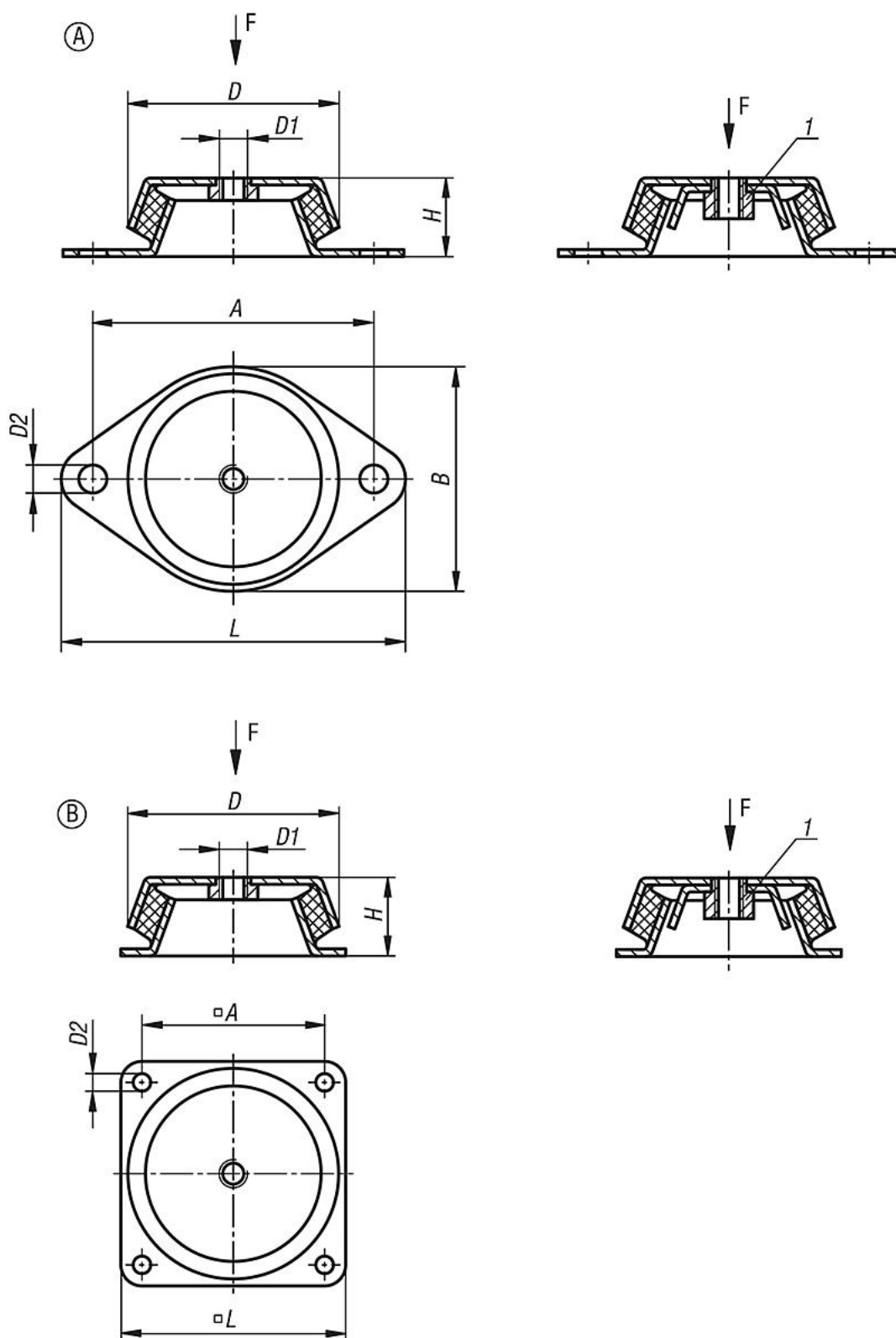

Overview of items

Order No.	Form	Version 1	A	B	D	D1	D2	H	L	Load rating max. kN
27760-062060	A	without shear protection	85	66	62	M10	8,2	30	110	1,5
27760-078060	A	without shear protection	110	78	78	M10	9	30	128	1,8
27760-092060	A	without shear protection	110	96	86	M12	10,2	45	140	3

Overview of items

Order No.	Form	Version 1	A	B	D	D1	D2	H	L	Load rating max. kN
27760-106060	A	without shear protection	140	110	106	M12	12,4	39	170	3,6
27760-062160	A	with tear protection	85	66	62	M10	8,2	30	110	1,5
27760-078160	A	with tear protection	110	78	78	M10	9	30	128	1,8
27760-092160	A	with tear protection	110	96	86	M12	10,2	45	140	3
27760-106160	A	with tear protection	140	110	106	M12	12,4	39	170	3,6
27760-150060	B	without shear protection	132	-	150	M16	12,5	51	168	8
27760-150160	B	with tear protection	132	-	150	M16	12,5	51	168	8