

## Item description/product images

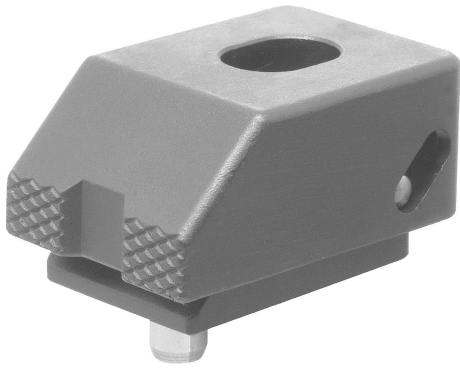

## Description

**Material:**  
Carbon steel.

**Version:**  
Tempered and black oxidised.

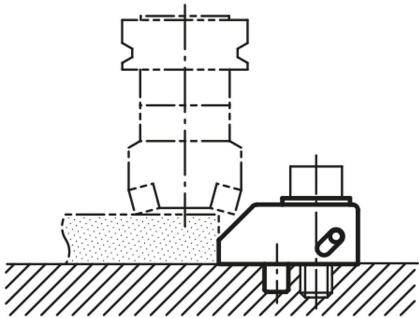

## Drawings

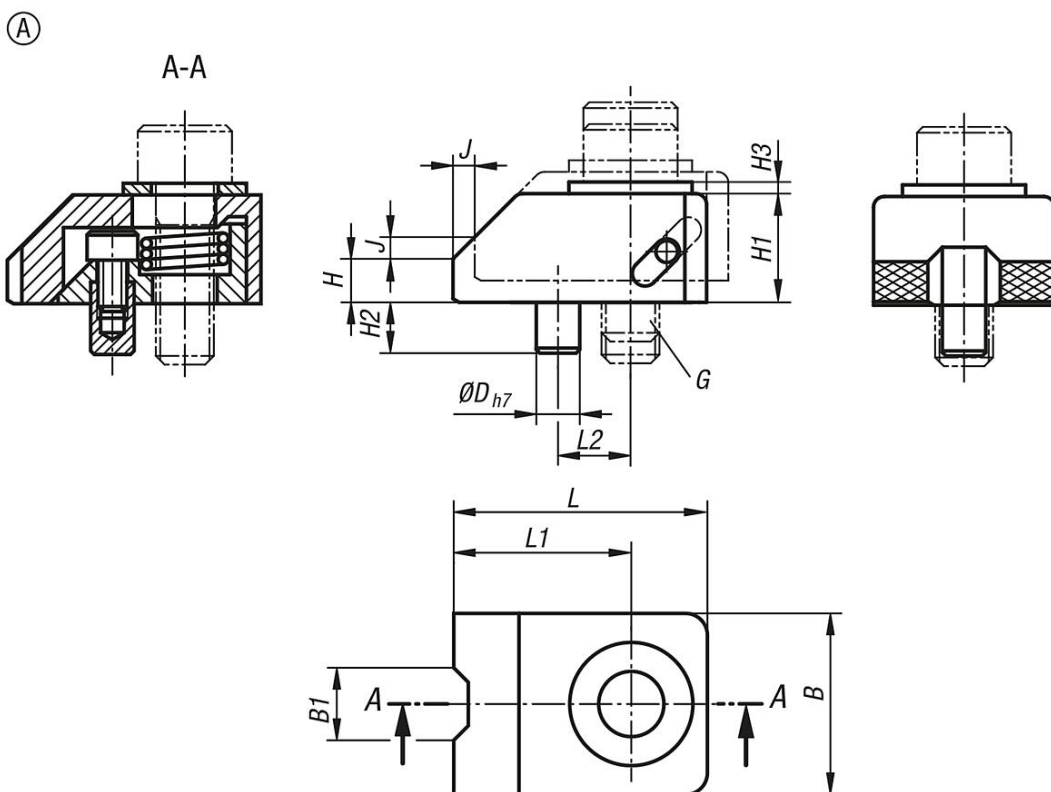

## Overview of items

Order No.	B	B1	D	G	H	H1	H2	H3	J	L	L1	L2	Clamping force N	Tightening torque Nm
04570-0806	25	10	6	M8	6	15	7	1,6	3	35	24,5	10	7000	25
04570-1008	30	11	6	M10	8	19	7	2	4	43	29	12	8500	50
04570-1209	35	12	8	M12	9	23	10	2,3	5	54	37	16	20000	90
04570-1610	40	14	10	M16	10	25	10	3,2	6	65	45	20	40000	200