

Item description/product images



Description

Material:

Carbon steel and ductile iron.

Version:

Tempered and black oxidised.

Wedge faces fine machined.

Note:

Fine adjustment by knurled screw or Allen key. Therefore vertical movement without lateral displacement. Especially suitable for marking or machining heavy parts. Ball handle 02210-01 is added to each height wedge.

H min is reached by removing the baseplate.

Drawing reference:

1) centring hole for 02210

Drawings

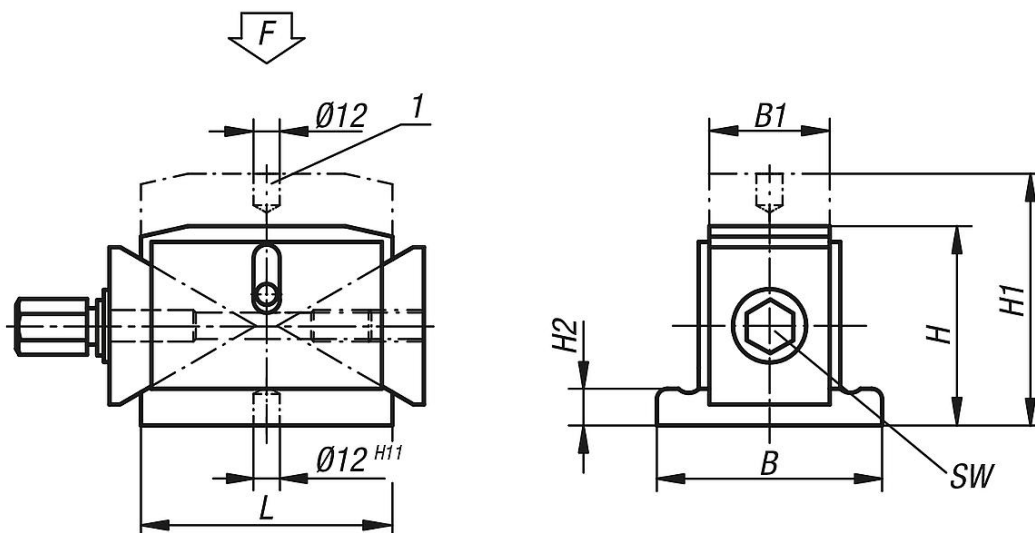

Overview of items

Order No.	Clamp range	B	B1	H	H1	H2	L	SW	travel per spindle rotation	F kN
02320-50	50 - 68	63	40	50	68	7	63	13	0,86	40
02320-100	100 - 125	115	60	100	125	20	125	24	1,16	100

