

## Item description/product images

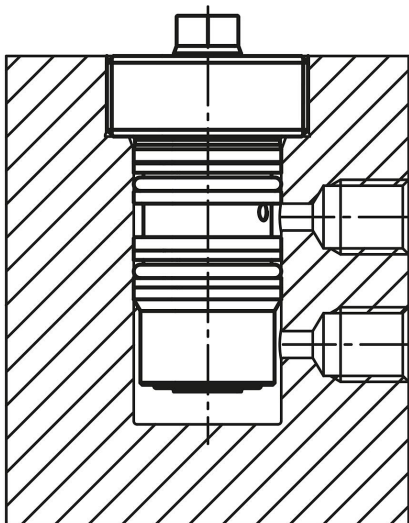

## Description

### Product description:

Cyclic-related, linear strokes are possible with the screw-in cylinders with double-acting function. Both travel directions are power actuated with the double-acting screw-in cylinders. Double-acting screw-in cylinders can be used as thrust or traction cylinders. These screw-in cylinders are often used on fixture plates and plates for plastic injection moulding tools.

The integrated metal wiper prevents damage to the piston rod surface by preventing swarf getting into the screw-in cylinder. The protection given by the seal ensures the longevity of the products.

### Material:

Housing and piston steel.

Seal NBR

### Version:

Housing black oxidised.

Piston hardened.

### Note:

Due to the compact design of these screw-in cylinders, no internal stop for the piston return stroke is installed. It must be ensured that the specified installation depth of the screw-in cylinders is adhered to, as these use the bottom of the mounting hole as a stop for the return stroke.

Care must be taken to ensure that no shavings remain in the drilled holes when producing the drilled channels for the screw-in cylinders. These can damage the seals of the screw-in cylinders, which can lead to leaks in the product.

To avoid damage to the seals during installation, make sure that the lead-in chamfers as well as the transverse holes for the oil supply are well rounded.

Thrust pieces are not supplied.

Follow safety instructions.

### Type of operation:

Drilled channels.

### Technical data:

Max. operating pressure: 500 bar.

### Assembly:

See mounting contour.

### On request:

Larger piston diameters and longer strokes.

### Accessory:

- Rest pads 02153.
- Self-aligning pads 02000, 02080, 02081, 02005, 02006.
- Gripper screws, hexagonal 07114.

### Drawing reference:

- 1) Mounting contour
- 2) Retract cylinder
- 3) Alternative oil supply, extend cylinder

Item description/product images

4) Rounded edges, max. R0.5

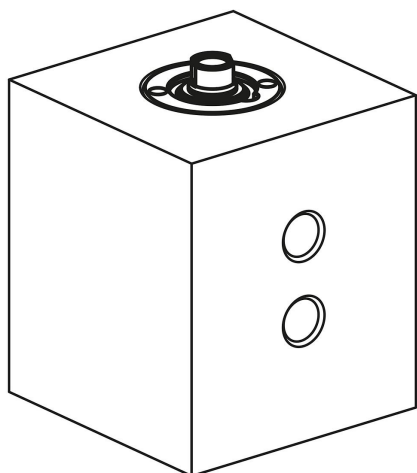

Drawings

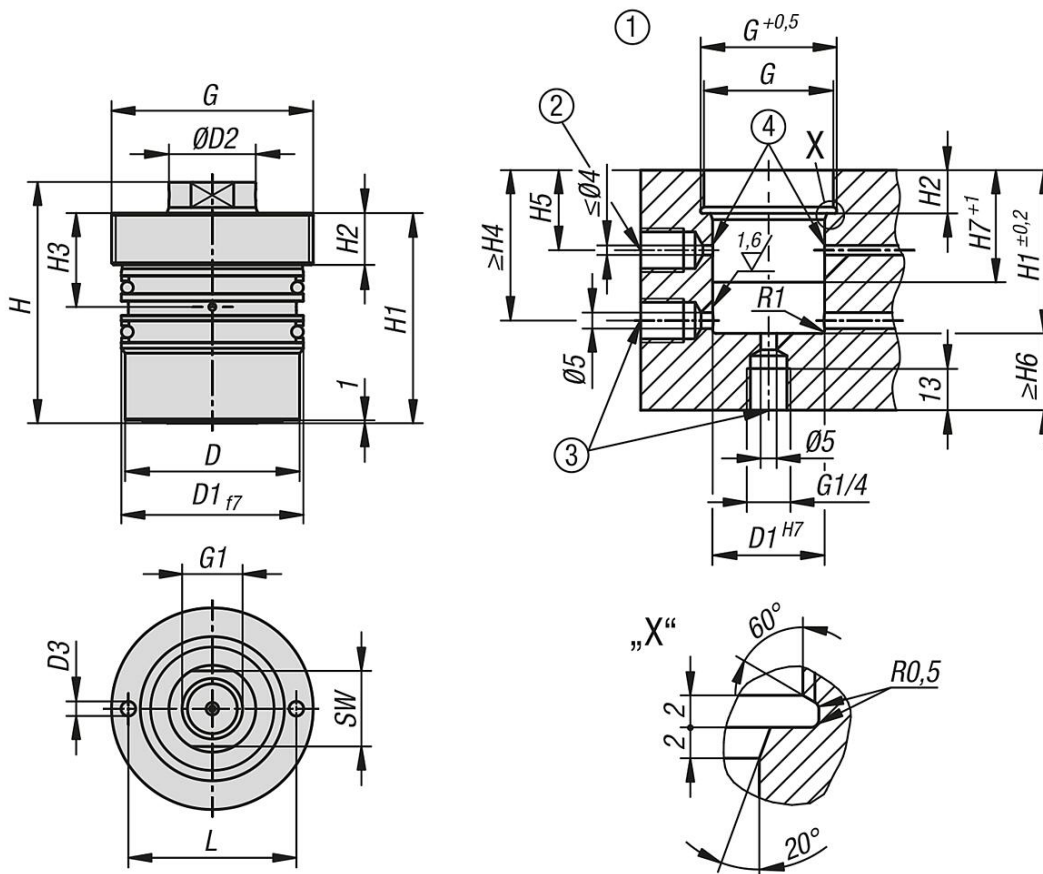

Overview of items

Order No.	Piston $\varnothing$	travel	Connection type	D	D1	D2	D3	G	G1	H	H1	H2	H3	H4	H5	H6	H7	L	SW
04624-60-161613061	16	16	drilled channels	20	22	10	3,5	M30x1,5	M6x15	56	50	12	24	45	24	8	38	23	8
04624-60-163213061	16	32	drilled channels	20	22	10	3,5	M30x1,5	M6x15	72	66	12	24	45	24	8	38	23	8
04624-60-165013061	16	50	drilled channels	20	22	10	3,5	M30x1,5	M6x15	90	84	12	24	45	24	8	38	23	8
04624-60-201613061	20	16	drilled channels	26	28	12	4,2	M36x1,5	M8x16	57	51	12	25	45	25	10	40	28	10
04624-60-203213061	20	32	drilled channels	26	28	12	4,2	M36x1,5	M8x16	73	67	12	25	45	25	10	40	28	10

## Overview of items

Order No.	Piston Ø	travel	Connection type	D	D1	D2	D3	G	G1	H	H1	H2	H3	H4	H5	H6	H7	L	SW
04624-60-205013061	20	50	drilled channels	26	28	12	4,2	M36x1,5	M8x16	91	85	12	25	45	25	10	40	28	10
04624-60-252013061	25	20	drilled channels	33	35	16	5,2	M42x1,5	M10x17	63	56	12	25	45	25	11	40	30	13
04624-60-255013061	25	50	drilled channels	33	35	16	5,2	M42x1,5	M10x17	93	86	12	25	45	25	11	40	30	13
04624-60-322513061	32	25	drilled channels	43	45	20	5,2	M56x2	M12x18	74	64	14,5	28	45	28	13	41	40	17
04624-60-325013061	32	50	drilled channels	43	45	20	5,2	M56x2	M12x18	99	89	14,5	28	45	28	13	41	40	17
04624-60-402513061	40	25	drilled channels	53	55	25	5,2	M64x2	M16x27	78	68	16,5	30	49	30	16	46	50	22
04624-60-405013061	40	50	drilled channels	53	55	25	5,2	M64x2	M16x27	103	93	16,5	30	49	30	16	46	50	22

Order No.	Piston Ø	Compressive force at 100 bar (kN)	Tractive force at 100 bar (kN)	Compressive force at 500 bar (kN)	Tractive force at 500 bar (kN)	Oil requirement / 10mm travel (cm <sup>3</sup> )	Oil requirement / 10mm return stroke (cm <sup>3</sup> )
04624-60-161613061	16	2	1,22	10	6,10	2	1,22
04624-60-163213061	16	2	1,22	10	6,10	2	1,22
04624-60-165013061	16	2	1,22	10	6,10	2	1,22
04624-60-201613061	20	3,14	2,02	15,70	10	3,14	2,02
04624-60-203213061	20	3,14	2,02	15,70	10	3,14	2,02
04624-60-205013061	20	3,14	2,02	15,70	10	3,14	2,02
04624-60-252013061	25	4,91	2,9	24,50	14,50	4,91	2,90
04624-60-255013061	25	4,91	2,9	24,50	14,50	4,91	2,90
04624-60-322513061	32	8,04	4,9	40,20	24,50	8,04	4,90
04624-60-325013061	32	8,04	4,9	40,20	24,50	8,04	4,90
04624-60-402513061	40	12,57	7,66	62,80	38,30	12,57	7,66
04624-60-405013061	40	12,57	7,66	62,80	38,30	12,57	7,66