



PRODUCT OVERVIEW

EDITION 2022

THE BIG
GREEN
BOOK ■



GREEN LIGHT
FOR ALL YOU
HAVE IN MIND

STANDARD AND OPERATING PARTS



OUR PRODUCT GROUPS



01000

Plates
Discs
Profiles

Tombstones
Workholding tower

02000

Self-aligning pads
Fixture feet

Clamp rests
Support elements

03000

Spring plungers
Indexing plungers
Stops

Centring and locating elements
Fasteners
Slot keys

04000

Clamp straps
Chain clamps
Cam clamps
Swing clamps

Clamping hook
Wedge clamps
Clamp nuts and screws
Side clamps, clamping elements for grid systems

05000

Toggle clamps
Pneumatic clamps
Clamping accessories

Latches
Quarter-turn locks

06000

Grips and knobs
Handwheels, crank handles and screw-in handles
Clamping and tension levers

Clamping joints
Pull handles, tubular handles and recessed handles

07000

Connecting elements
Ball-end thrust screws
Base plates
Ring bolts

Grub screws and thrust pads
Torque screws and threaded inserts
Hoist rings/lifting bolts

08000

Drilling jig elements
Drill bushes

09000

Magnets

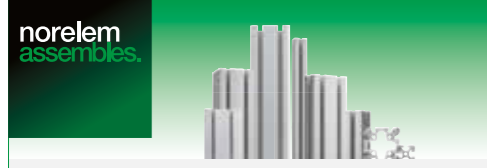

10000

Aluminium profiles
Connectors

Covers
Special elements

12000

Compressed air technology



20000

Linear modules
Lifting units

Rotary modules
Grip modules

21000

Carriage guides
Guide rails
Positioning stages

Telescopic slides
Miniature slide guides
Position indicators

22000

Chains and sprockets
Toothed belt pulleys
Splined shafts and toothed belts
V-belt

V-belt pulleys
Gear wheels and racks
Bevel gears
Worm screws and worm wheels
Transmissions



23000

Couplings
Rigid couplings
Keyless locking couplings
Universal joints

Quick-fit couplings
Bearings
Seals



24000

Trapezoidal thread spindles

Ball screw linear actuators
Bearing units



26000

Compression springs
Elastomer buffers
Rubber buffers

Shock absorbers
Gas springs



27000

Clevis joints
Rod ends
Angle joints
Brackets

Levelling sets
Levelling wedges, levelling feet, machine feet
Hinges

28000

Oil level gauges
Plugs
Screw plugs

Vent screws
Dipsticks
Filler necks

29000

Tube joints
Thread locks
Clamping elements

Tubes
Column components
Monitor brackets



31000

Inspection tables
Gauge stands
Joints

32000

Concentricity gauges
Dial gauges

33000

Standard elements for inspection and test fixtures



41000

Vices



80000

Connectors
Energy chains
Power supply units
Sensors

Cable fittings
Motors, lifting columns



95000

Wheels, castors
Ball transfer units
Small conveyor belts



96000

Feeler gauges
Protective nets
Supercraft soft faced hammers
Mallet inserts

Taper and cylinder cleaners
Coolant hoses
Magnetic labels and magnetic envelopes



97000

Lubricants
Adhesives
Grease nipples

norelem positions
Flexible standard component system

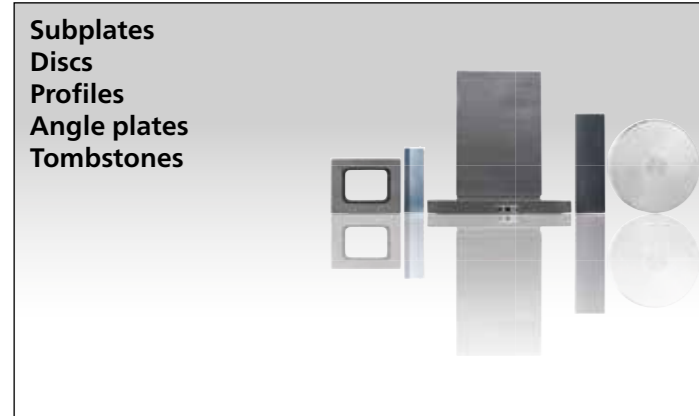

01040 Page 56	01127 Page 63	01180 Page 71	01380 Page 81
Base plate with T-slots grey cast iron	Interchangeable subplates, grey cast iron with grid holes	Base plate with flanges grey cast iron	L-profiles grey cast iron or aluminium
01041 Page 57	01130 Page 64	01250 Page 72	01440 Page 82
Baseplates aluminium with T-slot	Rectangular plates precision steel	Angle plates with or without T-slots cast iron	L-profiles unequal grey cast iron or aluminium
01042 Page 58	01140 Page 65	01252 Page 73	01520 Page 82
Baseplates aluminium with tapped holes	Plates grey cast iron or aluminium	Angle plates aluminium	L profile with reinforcing ribs grey cast iron
01060 Page 59	01148 Page 66	01265 Page 76	01560 Page 83
Base plates steel	Subplates, grey cast iron with pre-machined clamping faces	Tombstones, grey cast iron, double-sided, with pre-machined clamping faces	H-profiles grey cast iron or aluminium
01126 Page 60	01148 Page 68	01267 Page 78	01580 Page 83
Baseplates, grey cast iron with T-slots	Subplates, grey cast iron with T-slots	Tombstones, grey cast iron, double-sided, for interchangeable subplates	T-profiles machined all sides grey cast iron or aluminium
01126-10 Page 61	01150 Page 70	01270 Page 79	01640 Page 84
Baseplates, grey cast iron, round, with T-slots	Subplates machined all sides grey cast iron	Tombstone, grey cast iron, double-sided, for interchangeable subplates	V-block machined all sides grey cast iron or aluminium
01127 Page 62	01160 Page 71	01280 Page 80	01660 Page 84
Interchangeable subplates, grey cast iron, with pre-machined clamping faces	Block machined all sides grey cast iron or aluminium	Tombstones double-sided grey cast iron	V-block machined all sides extra wide, grey cast iron
		01320 Page 80	01680 Page 85
		Circular plates steel	U-profiles machined all sides grey cast iron or aluminium
		01320 Page 80	01740 Page 86
		Circular plates grey cast iron or aluminium	Square hollow profiles grey cast iron

+ New/Expanded Items

01000

norelem positions
Flexible standard component system

01760 Page 86	01780 Page 87	01820 Page 87	01850 Page 88	01850 Page 90	01852 Page 92
Rectangular hollow profiles grey cast iron	Angle profiles 60° grey cast iron	Angle profiles 45° grey cast iron	Workholding cubes, grey cast iron with pre-machined clamping faces	Workholding cubes, grey cast iron with T-slots	Tombstones cube grey cast iron

+ New/Expanded Items

02000

02000 Page 95	02007 Page 107	02001 Page 97	02008 Page 111	02002 Page 99	02009 Page 112	02003 Page 100	02010 Page 114, 1220	02004 Page 102	02010-01 Page 115	02005 Page 103	02020 Page 116	02006 Page 105	02020-01 Page 119
Self-aligning pads adjustable with O-ring and exchangeable inserts	Self-aligning pads adjustable with O-ring and hexagon socket	Self-aligning pads swivel angle 14° and 20°	Self-aligning pads adjustable with O-ring and hexagon socket	Self-aligning pads with O-ring	Self-aligning pads adjustable with O-ring, exchangeable inserts and hexagon socket	Self-aligning pads with O-ring and exchangeable inserts	Rest pads	Self-aligning pads self-righting	Rest pads, ceramic	Self-aligning pads adjustable	Locating pins and rest pads DIN 6321 (Issue 1973)	Self-aligning pads adjustable with O-ring	Locating pins ceramic similar to DIN 6321

norelem positions
Flexible standard component system

02025
Page 120



Locating pins with internal thread



02026
Page 121



Locating bushes for locating pins



02027
Page 122



Rest pads pin form, internal thread

02027
Page 123



Rest pads pin form, external thread

02028
Page 124



Rest pads

02029
Page 125



Rest pads with threaded pin, DIN 6320 (Edition 1971)

02030
Page 126



Extension pieces

02035-10
Page 127



Extension pieces

02035-10
Page 127



Swivel pads

02037
Page 128



Support bolts

02040
Page 130



Positioning feet

02041
Page 133



Positioning feet

02050
Page 134



Fixture feet with external thread

02070
Page 135



Fixture feet with internal thread

02080
Page 136



Self-aligning pads swivel 12°

02081
Page 139



Self-aligning pads self-righting

02090
Page 140



Locating feet

02110
Page 140



Screw rest with flat face, aluminium

02130
Page 141



Rest pads adjustable with locknut

02150
Page 141



Rest pads

02153
Page 142



Step blocks

02155
Page 143



Step block sets

02160
Page 144



Wedge supports

02170
Page 145



Support elements cylindrical

02171
Page 145



Workpiece supports adjustable

02180
Page 146



Workpiece supports

02182
Page 146



Workpiece support cylinders

02000

02190
Page 147



Atlas jack with locknut

02210
Page 148



Screw rest inserts spherical, centring disc, prism, locating pin, revolving ball

02270
Page 150



Step blocks

02310
Page 150



Workpiece supports

02320
Page 151



Jack screws

02330
Page 151



Inserts

02333
Page 152



Jack screws extended

02334
Page 153



Eccentric supports

02335
Page 154



Eccentric supports

norelem positions
Flexible standard component system

02340
Page 155



Support element

02350
Page 156



Rectangular support elements

02360
Page 156



Workpiece supports

02380
Page 157



Workpiece supports

02385
Page 158



Jack screws

02387
Page 158



Inserts

02388
Page 159



Jack screws extended

02390
Page 160

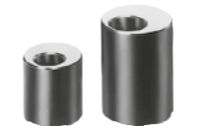

Eccentric supports

03000

Spring plungers
Indexing plungers
Stops
Centring/positioning components
Ball lock pins
T-slot nuts



03000
Page 163



Spring plungers with slot and ball, steel

03001
Page 164



Spring plungers with slot and ball, LONG-LOK secured, steel

03004
Page 165



Spring plungers with slot and POM ball, plastic

03008
Page 165



Spring plungers with slot and ceramic ball, stainless steel

03010
Page 166



Spring plungers with slot and ball, stainless steel

03011
Page 167



Spring plungers with slot and ball, LONG-LOK secured, stainless steel

03014
Page 168



Spring plungers with slot and stainless steel ball, plastic

03020
Page 169



Spring plungers with slot and thrust pin, steel

03020
Page 170



Spring plungers with status sensor

03021
Page 171



Spring plungers with slot and thrust pin, LONG-LOK secured, steel

03025
Page 172



Spring plungers with slot and thrust pin, stainless steel

03026
Page 173



Spring plungers with slot and thrust pin, LONG-LOK secured, stainless steel

03030
Page 174



Spring plungers with hexagon socket and ball, steel

03031
Page 175



Spring plungers with hexagon socket and ball, LONG-LOK secured, steel

+ New/Expanded Items

+ New/Expanded Items

norelem positions

Flexible standard component system

03033
Page 176



Spring plungers with hexagon socket and ceramic ball, stainless steel

03035
Page 177



Spring plungers with hexagon socket and ball, stainless steel

03036
Page 178



Spring plungers with hexagon socket and ball, LONG-LOK secured stainless steel

03040
Page 179



Spring plungers with hexagon socket and thrust pin, long version

03040
Page 180



Spring plungers with hexagon socket and thrust pin, steel

03040-02
Page 181



Spring plungers with hexagon socket and flattened thrust pin, steel

03041
Page 182



Spring plungers with hexagon socket and thrust pin, LONG-LOK secured, steel

03041-01
Page 183



Spring plungers with hexagon socket and flattened thrust pin, steel, LONG-LOK lock

03050
Page 184



Spring plungers with hexagon socket and POM thrust pin, steel

03050-01
Page 185



Spring plungers with hexagon socket and flattened POM thrust pin, steel

03051
Page 186



Spring plungers with hexagon socket and POM thrust pin, LONG-LOK secured, steel

03051-01
Page 187



Spring plungers with hexagon socket and flattened POM thrust pin, steel, LONG-LOK lock

03055
Page 188



Spring plungers with hexagon socket and thrust pin, stainless steel

03055-01
Page 189



Spring plungers with hexagon socket and flattened thrust pin, stainless steel

03056
Page 190



Spring plungers with hexagon socket and thrust pin, LONG-LOK secured, stainless steel

03056-01
Page 191



Spring plungers with hexagon socket and flattened thrust pin, stainless steel, LONG-LOK lock

03058
Page 192



Spring plungers with hexagon socket and POM thrust pin, stainless steel

03058-01
Page 193



Spring plungers with hexagon socket and flattened POM thrust pin, stainless steel

03059
Page 194



Spring plungers with hexagon socket and POM thrust pin, LONG-LOK secured, stainless steel

03059-01
Page 195



Spring plungers with hexagon socket and flattened POM thrust pin, stainless steel, LONG-LOK lock

03060
Page 196



Spring plungers with head

03065
Page 197



Spring plungers with detent ring

03069
Page 198



Locators

03070
Page 199



Spring plungers smooth version, stainless steel

03070
Page 198



Spring plungers smooth version, extended, stainless steel

03071
Page 200



Spring plungers smooth version, plastic

03072
Page 201



Spring plungers smooth version without collar, stainless steel

03000

03073
Page 201



Spring plungers with head

03074
Page 202



Spring plungers smooth version, double-sided

03075
Page 203



Double ball catches

03075-10
Page 204



Ball catch

03075-10
Page 204



Spacer for ball catch

03075-10
Page 205



Angle bracket for ball catch

03075-11
Page 206



Magnetic lock

03075-11
Page 207



Angle bracket for magnetic lock

03075-12
Page 208



Door stops plastic for aluminium profile with buffer or with magnetic catch

norelem positions

Flexible standard component system

03076
Page 209



Spring plungers smooth version, self-clamping, plastic

03077
Page 210



Spring plungers smooth version

03080
Page 211



Eccentric stops

03081
Page 212



Clamp stops adjustable for slot profiles

03083
Page 213



Stops adjustable

03085
Page 213



Screw stops adjustable

03086
Page 214



Stop screws

20010
Page 50, 214



Stop screws

03087
Page 215



Stop screws

03088
Page 216



5D workpiece stops

03089
Page 219



Indexing plungers

03089
Page 221



Indexing plungers

03089
Page 223



Indexing plungers with thread lock

03089
Page 225



Indexing plungers with extended indexing pin

03089
Page 227



Indexing plungers short version

03089
Page 229



Indexing plungers short version

03089
Page 231



Indexing plungers short version, with thread lock

03089
Page 232



Indexing plungers stainless steel

03089
Page 233



Indexing plungers for thin-walled parts

03089
Page 234



Indexing plungers - Premium with cylindrical pin

03089
Page 235



Bushes cylindrical

03089
Page 236



Indexing plungers - Premium with tapered pin

03089
Page 237



Bushes tapered

03089
Page 238



Spacer rings

03089
Page 239



Indexing plungers ECO

03089
Page 240



Indexing plunger with lock

03089-10
Page 241



Indexing plungers with rotation lock and lead-in chamfer

03000

03090
Page 243



Indexing plungers

03090
Page 244



Indexing plungers with locked mark

03090
Page 247



Indexing plungers with T-grip

03090
Page 248



Indexing plungers ECO short version

03091
Page 249



Indexing plungers

03092
Page 251



Indexing plungers

03092
Page 253



Indexing plungers

03093
Page 255



Indexing plungers without collar

03093
Page 257



Indexing plungers without collar, extended indexing pin

+ New/Expanded Items

+ New/Expanded Items

norelem positions
Flexible standard component system

03093
Page 259



Indexing plungers stainless steel without collar

03094
Page 261



Indexing plungers without collar

03095
Page 262



Indexing plungers, pneumatic

03096
Page 265



Indexing plungers without collar

03096
Page 267



Indexing plungers without collar

03096-10
Page 269



Indexing plunger, stainless steel with remote actuation

03097
Page 271



Indexing plungers without collar

03098
Page 273



Indexing plungers without collar

03098
Page 274



Indexing plungers without collar

03099
Page 275



Cam-action indexing plungers

03099-20
Page 276



Cam action indexing plunger with stop

03099
Page 278



Cam-action indexing plungers stainless steel

03099-21
Page 279



Cam action indexing plunger stainless steel, with stop

03099
Page 280



Mounting brackets steel

03099-50
Page 281



Positioning bushes for indexing plungers

03099
Page 283



Mounting brackets aluminium

03099
Page 284



Cam-action indexing plungers

03099
Page 285



Cam-action indexing plungers stainless steel

03102
Page 286



Barrel slide bolts

03105
Page 291



Locating pins removable Form A and C

03106
Page 291



Locating pins removable Form B and D

03107
Page 292



Locating pins with ball-end Form A

03107
Page 292



Locating pins with flattened ball-end Form C

03108
Page 293



Locating pins with ball-end Form B

03108
Page 293



Locating pins with flattened ball-end Form D

03110
Page 294



Centring pins for central hole

03112
Page 294



Centring pins for aligning hole

03114
Page 295



Centring pins for aligning hole

03120
Page 296



Positioning pins cylindrical ground

03130
Page 296



Positioning pins cylindrical not ground

03140
Page 297



Positioning pins free-milled ground

03150
Page 297



Positioning pins free-milled not ground

03151
Page 298



Locating pins expanding

03152-10
Page 302



Positioning cones, steel for centring units

03152-11
Page 303



Positioning bush steel for centring units

03153
Page 305



Locating cylinder Ball Lock

03000

norelem positions
Flexible standard component system

03153-02
Page 306



Locating cylinder, stainless steel Ball Lock

03153
Page 307



Locating cylinders with quick clamping system

03154
Page 308



Centring bushes

03154-02
Page 309



Centring bushes stainless steel

03155
Page 310



Locating bushes Form A (pressed in from rear)

03155-02
Page 310



Locating bushes, stainless steel Form A (pressed in from rear)

03156
Page 311



Locating bushes Form B (screwed down from front)

03156-02
Page 311



Locating bushes, stainless steel Form B (screwed down from front)

03157
Page 312



Mandrel collets

03157
Page 313



Mandrel collets with side lock

03157-10
Page 314



Mandrel collet for small bores

03157-15
Page 315



Mandrel collets, steel with cam lever

03158
Page 317



Centring clamps with ball or hexagon segments

03158
Page 319



Centring clamps with ball or hexagon segments

03160
Page 320



Centring V

03161
Page 322



Locating cylinders pneumatic

03161-02
Page 323



Locating cylinders pneumatic

03161-03
Page 324



Locating bushes for pneumatic locating cylinder

03162
Page 325



Locating bushes for pneumatic locating cylinder

03163
Page 326



Machinable collets, square

03164
Page 328



Centring clamps round

03165
Page 330



Centring clamps

03167
Page 331



Adapter for collet

03168
Page 332



Collet for external clamping

03168
Page 334



Collet for internal clamping

03169
Page 339



Traction cone for internal clamping collet

03178-10
Page 340



Machinable collets pneumatic

03180
Page 342

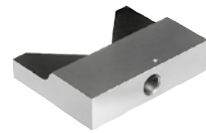

Centring V-plate

03182
Page 343



Indexing plungers - Precision with tapered pin

03184
Page 343



Bushes tapered

03186
Page 344



Indexing plungers - Precision with cylindrical pin

03188
Page 344



Bushes cylindrical

03190
Page 346



Indexing plunger with five lobe grip

03190-10
Page 349



Indexing and clamping grip

03191
Page 351



Indexing and clamping grip with optical locked indicator

03193
Page 352



Ball lock pins

03000

+ New/Expanded Items

+ New/Expanded Items

norelem positions

Flexible standard component system

03194
Page 353



Ball lock pins stainless steel

03197-05
Page 362



Locating bushes with collar, stainless steel for ball lock pins

03250
Page 368



Slot keys

03194
Page 354



Ball lock pins with mushroom grip stainless steel

03198
Page 363



Safety cable

03252
Page 369



Elastic slot keys Pat. No. 4200676

03194
Page 355



Ball lock pins with grip ring stainless steel

03199
Page 363



Safety spiral cable

03260
Page 370



Slot keys loose DIN 6323

03195
Page 356



Locking pins

03199
Page 364



Key rings

03270
Page 370



Slot keys with locating pin

03195
Page 357



Locking pins with key ring

03199
Page 365



Retaining cables

03288
Page 371



Parallel keys DIN 6885 A

03196
Page 358



Ball lock pins with T-grip

03200
Page 366



Parallel blocks pair DIN 6346

03288-01
Page 372



Parallel key, ceramic similar to DIN 6885 A

03196
Page 359



Ball lock pins with L-grip

03212
Page 367



Parallel block sets

03289
Page 373



Woodruff keys DIN 6888

03197
Page 360



Bushing for ball lock pins

03220
Page 367

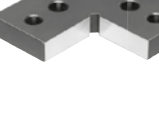

Positioning brackets

03290
Page 374



Carrier keys DIN 2079

03197
Page 361



Bushing for ball lock pins with LONG-LOK thread lock

03240
Page 368

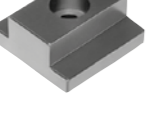

T-slot keys

03315
Page 375



Roll dowel heavy duty ISO 8752

03000

03320
Page 376



Cylindrical pins DIN 6325

03320-01
Page 376



Ceramic dowel pins similar to DIN 6325

03325
Page 377



Cylindrical pins with internal thread DIN EN ISO 8735

03325-01
Page 377



Ceramic dowel pins with female thread similar to DIN 7979

03328
Page 378



Extractor

03330
Page 381



Lateral spring plungers

03330
Page 380-382



Eccentric bushes and assembly tools for lateral spring plungers

03331
Page 383



Eccentric bushes with centre bore

03332
Page 384



Lateral spring plungers without thrust pin

norelem positions

Flexible standard component system

03334
Page 386



Lateral spring plungers with threaded sleeve

03336
Page 388



Lateral spring plungers with threaded sleeve, without thrust pin

03338
Page 389



Push-Pull spring plungers

03339
Page 390

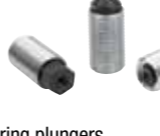

Push-Pull spring plungers with rotation lock

03340
Page 391



Lateral spring plungers

03350
Page 392



Shaft clamping units

03351
Page 393



Threaded clamping bushes

03400
Page 394



Locking pins with folding latch

03410
Page 395



Locking pins with axial locking

03412
Page 396



Locking pins with magnetic axial lock

03415
Page 397



Ball lock pins stainless steel

03415
Page 398



Ball lock pins, stainless steel with high shear strength

03415-10
Page 399



Ball lock pins stainless steel, with headend lock

03418
Page 400



Ball lock pins with mushroom grip stainless steel

03418-10
Page 403



Ball lock pins with mushroom grip stainless steel, adjustable

03418-10
Page 405



Ball lock pins with mushroom grip stainless steel, with high shear strength, adjustable

03420
Page 406



Ball lock pins

03420
Page 408



Ball lock pins with L-grip

03420
Page 409



Ball lock pins with L-grip with high shear strength

03420
Page 410



Ball lock pins with T-grip

03420
Page 411



Ball lock pins with T-grip with high shear strength

03420-10
Page 412



Ball lock pins with T-grip stainless steel, with headend lock

03420-10
Page 414



Ball lock pins with T-grip stainless steel, with head-end lock

03420-10
Page 413



Ball lock pins with L-grip stainless steel, with head-end lock

03422
Page 418



Ball lock pins with zinc T-grip

03422
Page 419



Ball lock pins with T-grip with high shear strength

03422
Page 416



Ball lock pins with zinc L-grip

03422
Page 417



Ball lock pins with L-grip with high shear strength

03425
Page 420



Locating bushes stainless steel for ball lock pins

03000

+ New/Expanded Items

+ New/Expanded Items

norelem positions
Flexible standard component system

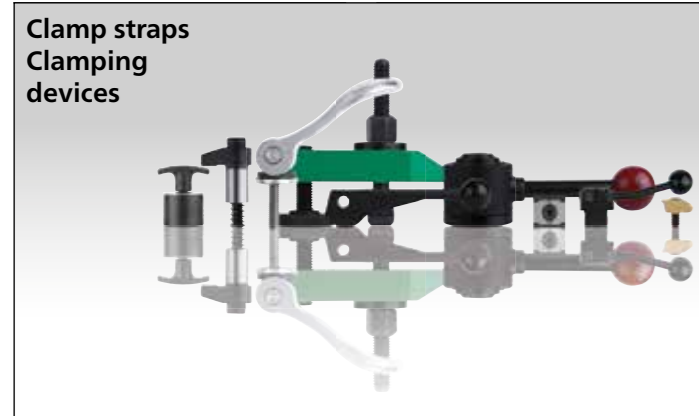

- 04010** Page 422
- 04090** Page 428
- 04030** Page 423
- 04050** Page 423
- 04070** Page 424
- 04080** Page 425
- 04081** Page 426
- 04088** Page 427
- 04190** Page 436
- 04185** Page 435
- 04100** Page 429
- 04110** Page 430
- 04130** Page 431
- 04131** Page 432
- 04140** Page 433
- 04150** Page 434

- 04170** Page 435
- 04185** Page 435
- 04190** Page 436
- 04191** Page 437
- 04192** Page 438
- 04193** Page 439
- 04195** Page 439
- 04200** Page 440
- 04203** Page 443

- 04000**
- 04204** Page 444
 - 04205** Page 445
 - 04210** Page 445
 - 04211-03** Page 447
 - 04211-06** Page 448
 - 04211-09** Page 449
 - 04232** Page 451
 - 04232** Page 452

- norelem positions**
Flexible standard component system
- 04232** Page 455
 - 04232** Page 456
 - 04232** Page 458
 - 04233** Page 460
 - 04233** Page 461
 - 04233** Page 462
 - 04233** Page 463
 - 04233** Page 464
 - 04233** Page 465
 - 04250** Page 465
 - 04270** Page 465
 - 04290** Page 466
 - 04310** Page 466
 - 04330** Page 467
 - 04350** Page 467
 - 04360** Page 468
 - 04362** Page 468
 - 04363** Page 470
 - 04364** Page 471
 - 04370** Page 475
 - 04370** Page 476
 - 04370** Page 477
 - 04371** Page 478
 - 04371** Page 479
 - 04371** Page 480
 - 04372** Page 483
 - 04373** Page 484
 - 04374** Page 485
 - 04375** Page 486
 - 04378** Page 487
 - 04379** Page 488
 - 04380** Page 489
 - 04390** Page 489
 - 04395** Page 490
 - 04400** Page 491

- 04000**
- 04365** Page 473
 - 04366** Page 474
 - 04370** Page 475
 - 04370** Page 476
 - 04371** Page 478
 - 04371** Page 479
 - 04371** Page 480
 - 04372** Page 483
 - 04373** Page 484
 - 04374** Page 485
 - 04375** Page 486
 - 04378** Page 487
 - 04379** Page 488
 - 04380** Page 489
 - 04390** Page 489
 - 04395** Page 490
 - 04400** Page 491

+ New/Expanded Items

+ New/Expanded Items

norelem positions
Flexible standard component system

<p>04400 Page 491</p> <p>Clamping pins (high force)</p>	<p>04421 Page 504</p> <p>Floating clamp with separate workpiece clamp and interlock</p>	<p>04435 Page 515</p> <p>Cam screws with hexagon washer</p>	<p>04450 Page 523</p> <p>Low-profile clamps</p>
<p>04400 Page 492</p> <p>Clamping screws</p>	<p>04422 Page 506</p> <p>Clamping jaws for floating clamps</p>	<p>04436 Page 516</p> <p>Cam screws with hexagon washer, for T-slots</p>	<p>04460 Page 524</p> <p>Side clamps</p>
<p>04400 Page 492</p> <p>Clamping screws (high force)</p>	<p>04430 Page 508</p> <p>Clamping element "arness"</p>	<p>04437 Page 517</p> <p>Cam clamps with riser</p>	<p>04461 Page 525</p> <p>Side clamps with support</p>
<p>04400 Page 494</p> <p>Pull clamps</p>	<p>04430-10 Page 510</p> <p>Clamp cam brass</p>	<p>04439 Page 517</p> <p>Toe clamps for T-slots</p>	<p>04462 Page 526</p> <p>T-slot clamps</p>
<p>04400 Page 491-492, 495</p> <p>Pull clamps (high force)</p>	<p>04431 Page 511</p> <p>Fixture clamps machinable</p>	<p>04440 Page 518</p> <p>Talon grips</p>	<p>04469 Page 527</p> <p>T-slot clamp</p>
<p>04403 Page 496</p> <p>Pull clamps pneumatic</p>	<p>04431-05 Page 512</p> <p>Clamping cams</p>	<p>04440 Page 519</p> <p>Talon grips round</p>	<p>04470 Page 528</p> <p>T-slot clamps</p>
<p>04403-01 Page 498</p> <p>Draw bolts for pneumatic pull clamps</p>	<p>04432 Page 513</p> <p>Fixture clamps unequal hexagon</p>	<p>04441 Page 520</p> <p>Chock clamps</p>	<p>04472 Page 529</p> <p>T-slot clamp with cam</p>
<p>04410 Page 501</p> <p>Clamping element "actima"</p>	<p>04433 Page 514</p> <p>Spiral cam screws</p>	<p>04444 Page 521</p> <p>Cam clamps adjustable with riser</p>	<p>04480 Page 530</p> <p>Side clamps</p>
<p>04420 Page 502</p> <p>Floating clamp</p>	<p>04434 Page 515</p> <p>Cam screws with knife edge washer</p>	<p>04445 Page 522</p> <p>Riser stops</p>	<p>04485 Page 531</p> <p>Side clamps with rest pad</p>

+ New/Expanded Items

04000

norelem positions
Flexible standard component system

<p>04500 Page 532</p> <p>Side clamps robust</p>	<p>04522 Page 541</p> <p>Wedge clamps</p>	<p>04562 Page 551</p> <p>Side clamps</p>	<p>04620 Page 561</p> <p>Down-thrust clamps</p>
<p>04500-01 Page 533</p> <p>Fixed jaws for robust side clamps</p>	<p>04523 Page 542</p> <p>Wedge clamps machinable</p>	<p>04567 Page 553</p> <p>Wedge clamps</p>	<p>04624 Page 562</p> <p>Hold-down clamps pneumatic</p>
<p>04509 Page 534</p> <p>Side clamps</p>	<p>04524 Page 543</p> <p>Wedge clamps jaw face smooth or serrated</p>	<p>04570 Page 554</p> <p>Toe clamps</p>	<p>04625 Page 564</p> <p>Compact clamps</p>
<p>04512 Page 535</p> <p>Seating blocks adjustable</p>	<p>04524 Page 544</p> <p>Wedge clamps machinable</p>	<p>04571 Page 555</p> <p>Flat clamps</p>	<p>04626 Page 565</p> <p>Riser blocks with draw bolt</p>
<p>04515 Page 536</p> <p>Side clamp with cam</p>	<p>04525 Page 545</p> <p>Wedge clamps jaw faces serrated</p>	<p>04571-10 Page 556</p> <p>Flat clamp, steel for T-slot</p>	<p>04629 Page 567</p> <p>Power clamp</p>
<p>04516 Page 537</p> <p>Side clamps</p>	<p>04526 Page 546</p> <p>Wedge clamps machinable</p>	<p>04575 Page 557</p> <p>Side clamps</p>	<p>04629-10 Page 569</p> <p>Power clamp 3 stage</p>
<p>04518 Page 538</p> <p>Side clamps</p>	<p>04527 Page 547</p> <p>Wedge clamps double jaw faces serrated</p>	<p>04578 Page 558</p> <p>Side clamps</p>	<p>04630 Page 570</p> <p>Risers for power clamp</p>
<p>04520 Page 539</p> <p>Side clamps</p>	<p>04530 Page 549</p> <p>Side clamps</p>	<p>04579 Page 559</p> <p>Side Clamp</p>	<p>04631 Page 571</p> <p>Thrust pads for power clamp</p>
<p>04521 Page 540</p> <p>Toe clamps compact</p>	<p>04540 Page 550</p> <p>Side stops</p>	<p>04610 Page 560</p> <p>Swivel hold-down clamps mini, with cam lever</p>	<p>04750 Page 572</p> <p>Clamp nuts</p>

+ New/Expanded Items

norelem positions
Flexible standard component system



Clamp nuts with star or T-grip



Tightening screws



Clamping pin, steel



Clamping pin, steel or stainless steel with washer



Clamping pin, steel or stainless steel with clamping angle



Clamping pin, steel or stainless steel with adapter plate



Pivot bearing, steel with external thread



Plate, steel open



Angle, steel open

04000/05000



Toggle clamps vertical with horizontal foot

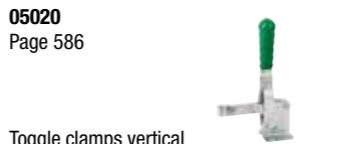

Toggle clamps vertical with horizontal foot and full clamping lever



Toggle clamps vertical with horizontal foot, large version



Toggle clamps vertical with straight foot



Toggle clamps vertical with angled foot



Toggle hook clamps and catch plate



Toggle clamps horizontal with horizontal foot



Toggle clamps horizontal large version



Toggle clamps horizontal with straight foot



Toggle mini clamps



Toggle clamps horizontal with push rod



Toggle clamps with push rod push-pull operation, for bracket mounting



Plastic grips



Thrust spindles spring mounted

norelem positions
Flexible standard component system

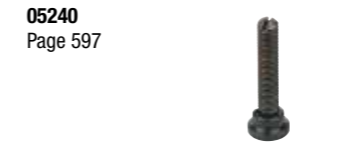

Thrust screws with thrust pad

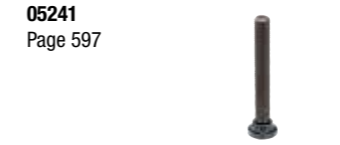

Thrust screws with thrust pad

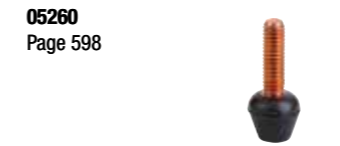

Thrust screws neoprene



Protective caps



Toggle clamps variable horizontal with horizontal foot



Toggle clamps variable vertical with horizontal foot



Toggle clamps variable with thrust rod

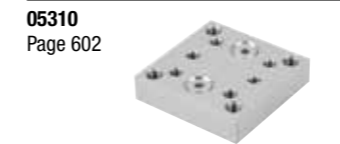

Adapter block aluminium



Adapter plates round



Pneumatic clamp



Pneumatic clamps vertical with vertical cylinder bracket



Pneumatic clamps push-rod



Pneumatic clamps vertical heavy-duty version



Toggle clamps heavy duty vertical



Toggle clamps heavy duty version straight foot



Plastic grips



Latches with spring clip



Latch stainless steel DIN 3133



Latches with draw bail



Latches with draw bail

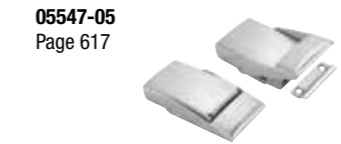

Latches with release stainless steel



Latches adjustable with swing bail



Latches adjustable heavy-duty version



Adjustable latches heavy-duty version



Quarter-turn locks compact



Quarter-turn lock, stainless steel



Quarter-turn locks compact with wing grip



Quarter-turn locks compact lockable



Quarter-turn locks



Quarter-turn locks stainless steel, small version



Quarter-turn locks, stainless steel long version



Quarter-turn locks stainless steel, small version



Quarter-turn locks lockable, stainless steel



Tongue for quarter-turn lock

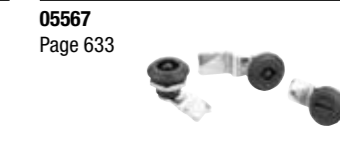

Quarter-turn locks polyamide

05000

+ New/Expanded Items

+ New/Expanded Items

norelem positions
Flexible standard component system



05568
Page 635
Quarter-turn locks long version



05578-02
Page 644
Quarter-turn security locks, stainless steel



05593-04
Page 652
Quarter-turn locks in Hygienic DESIGN with T-grip



Clamping arm for swing clamp



05571
Page 636
Quarter-turn locks with wing grip



05584
Page 645
Dust caps



05594
Page 653
Quarter-turn locks stainless steel with L-grip

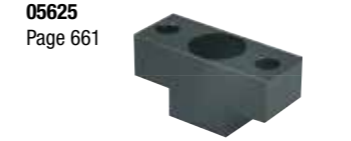

05625
Page 661
Adapters for swing clamp



05571-02
Page 637
Quarter-turn lock stainless steel with wing grip



05585
Page 645
Opening grips



05594-02
Page 654
Quarter-turn locks stainless steel with L-grip



05650
Page 665
Mini clamps



05572
Page 638
Quarter-turn locks with T-grip



05586
Page 646
Keys for quarter-turn locks



05595
Page 655
Quarter-turn locks for sterile areas



05652
Page 667
Mini clamp manual operated



05573
Page 639
Quarter-turn locks with L-grip

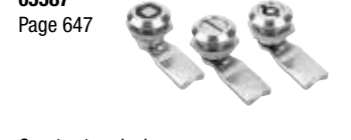

05587
Page 647
Quarter-turn locks stainless steel



05595-01
Page 656
Quarter-turn locks in Hygienic DESIGN



05660
Page 668
Swing screws



05574
Page 640
Compression latches



05588
Page 648
Quarter-turn locks stainless steel, lockable



05595-02
Page 657
Quarter-turn locks in Hygienic DESIGN



05665
Page 671
Mini clamp for horizontal installation



05575
Page 641
Compression latches with adjustable tongue height



05589
Page 649
Quarter-turn locks stainless steel with wing grip



05598
Page 658
Slam latches



05666
Page 672
Manual clamp vertical with hole pattern on the front

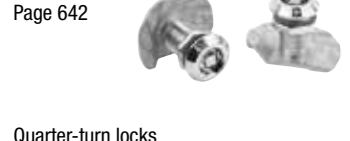

05576
Page 642
Quarter-turn locks with cam tongue



05593
Page 650
Quarter-turn locks stainless steel with T-grip



05599
Page 659
Emergency openers



05667
Page 673
Manual clamp vertical with hole pattern on the front



05577
Page 643
Quarter-turn locks free-turning



05593-01
Page 651
Quarter-turn locks stainless steel with T-grip

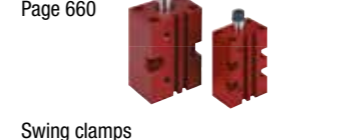

05610
Page 660
Swing clamps pneumatic



05840
Page 674
Push-pull clamps heavy-duty version with handle

+ New/Expanded Items

05000

norelem positions
Flexible standard component system



05880
Page 675, 679, 689
Angle bracket



05904
Page 686
Toggle clamps horizontal with safety interlock with straight foot and adjustable clamping spindle, stainless steel

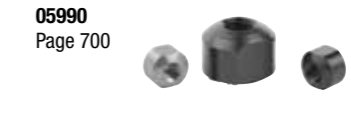

05990
Page 700
Spherical seating nuts



05882
Page 675
Plastic grips



05908
Page 689
Toggle clamps vertical with flat foot and adjustable clamping spindle



05990-20
Page 701
Status sensors, stainless steel with bracket for toggle clamps



05900
Page 679
Toggle clamps horizontal with flat foot and adjustable clamping spindle



05908
Page 691
Toggle clamps vertical with flat foot and adjustable clamping spindle, stainless steel



05900
Page 680
Toggle clamps horizontal with flat foot and adjustable clamping spindle, stainless steel

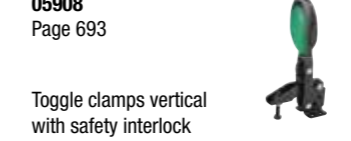

05908
Page 693
Toggle clamps vertical with flat foot and adjustable clamping spindle



05900
Page 681
Toggle clamps horizontal with safety interlock with flat foot and adjustable clamping spindle, stainless steel

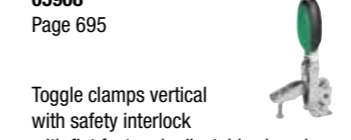

05908
Page 695
Toggle clamps vertical with safety interlock with flat foot and adjustable clamping spindle



05900
Page 682
Toggle clamps horizontal with safety interlock with flat foot and adjustable clamping spindle, stainless steel

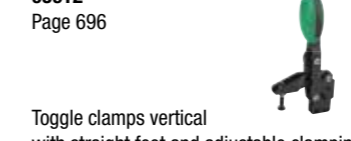

05912
Page 696
Toggle clamps vertical with straight foot and adjustable clamping spindle



05904
Page 683
Toggle clamps horizontal with straight foot and adjustable clamping spindle

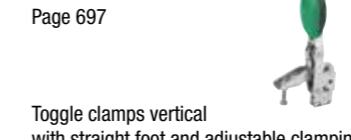

05912
Page 697
Toggle clamps vertical with straight foot and adjustable clamping spindle, stainless steel



05904
Page 684
Toggle clamps horizontal with straight foot and adjustable clamping spindle, stainless steel

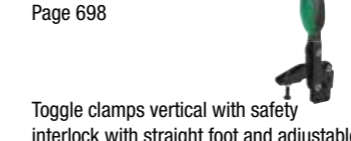

05912
Page 698
Toggle clamps vertical with safety interlock with straight foot and adjustable clamping spindle



05904
Page 685
Toggle clamps horizontal with safety interlock with straight foot and adjustable clamping spindle

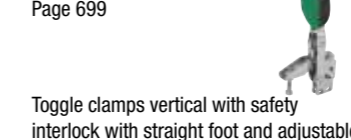

05912
Page 699
Toggle clamps vertical with safety interlock with straight foot and adjustable clamping spindle, stainless steel

+ New/Expanded Items

05000

norelem positions
Flexible standard component system

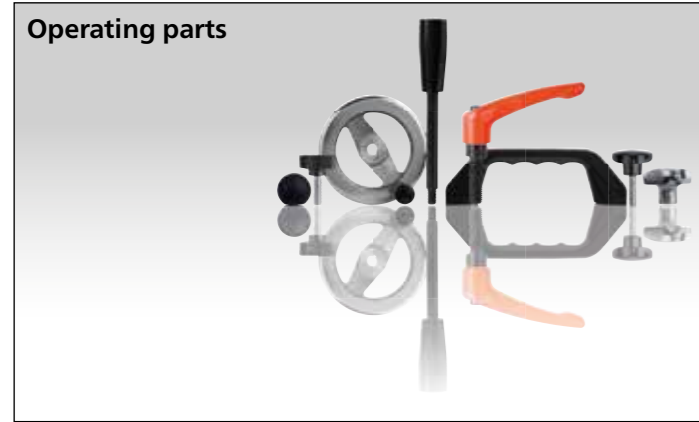

06010 Page 704	06090 Page 710
Knurled nuts steel and stainless steel, DIN 6303	Knurled screws high form steel and stainless steel, DIN 464
06013 Page 705	06091 Page 710
Knurled nuts plastic	Knurled thumb screws plastic
06014 Page 706	06091-01 Page 711
Knurled nuts plastic	Knurled screws plastic
06014 Page 707	06091-01 Page 712
Knurled nuts plastic, antistatic	Knurled screws plastic, antistatic
06030 Page 708	06092 Page 713
Knurled nuts quick-acting	Knurled knobs
06070 Page 709	06092 Page 714
Knurled nuts	Knurled knobs antistatic
06089 Page 709	06094 Page 715
Knurled screws low head steel and stainless steel, DIN 653	Knurled knobs

06000

06096 Page 716	06133 Page 724
Knurled knobs aluminium	Wing grips for hexagon socket screws
06097 Page 717	06134 Page 724
Knurled knobs	Disc grips for hexagon socket screws
06100 Page 718	06140 Page 725
Knurled knobs	Tommy bars with fixed or sliding T-bar, DIN 6305 or DIN 6307
06105 Page 719	06150 Page 726
Knurled knobs with arrow	T-thrust screws with fixed or sliding T-bar, DIN 6304 or DIN 6306
06110 Page 720	06156 Page 728
Knurled nuts high steel and stainless steel, DIN 466	Palm grips aluminium, similar to DIN 6335
06120 Page 720	06158 Page 731
Knurled nuts flat steel and stainless steel, DIN 467	Palm grips stainless steel, similar to DIN 6335
06130 Page 721	06160 Page 732
Knurled screws	Palm grips grey cast iron DIN 6335
06131 Page 722	06161 Page 733
Knurled knobs for screws with hex head	Palm grips plastic coated grey cast iron, DIN 6335
06132 Page 723	06170 Page 733
Knurled heads for hexagon socket screws	Palm grips with threaded spindle

+ New/Expanded Items

norelem positions
Flexible standard component system

06180 Page 734	06210 Page 747
Palm grips similar to DIN 6335	Star grips with projecting steel bush
06181 Page 735	06210-10 Page 748
Palm grips similar to DIN 6335 metal parts stainless-steel	Star grips, plastic with clamping force intensifier
06190 Page 736	06211 Page 749
Palm grips quick-acting grey cast iron	Star grips with extended collar
06192 Page 738	06212 Page 750
Star grips aluminium, similar to DIN 6336	Star grips metal parts stainless steel, similar to DIN 6336
06194 Page 741	06212 Page 751
Star grips stainless steel, similar to DIN 6336	Star grips with safety cable metal parts stainless steel, similar to DIN 6336
06200 Page 742	06220 Page 752
Star grips grey cast iron, DIN 6336	Star grips similar to DIN 6336
06208 Page 743	06220 Page 754
Star grips similar to DIN 6336	Star grips antistatic similar to DIN 6336
06209 Page 744	06220 Page 757
Star grips similar to DIN 6336, metal parts stainless steel	Star grips with safety cable similar to DIN 6336
06209-01 Page 745	06222 Page 758
Star grips, plastic with protruding steel bush	Star grips quick-acting

+ New/Expanded Items

06000

06230 Page 758	06242 Page 766
Four-spoked nuts	Mushroom knobs external thread
06235 Page 759	06242 Page 767
Capstan wheel	Mushroom knobs antistatic external thread
06237 Page 760	06245 Page 768
Knobs flat	Spherical knobs
06238 Page 761	06246 Page 769
Mushroom knobs internal thread	Spherical knobs revolving
06239 Page 761	06247 Page 770
Mushroom knobs external thread	Ball knobs thermoplastic DIN 319 enhanced
06240 Page 762	06247 Page 771
Mushroom knobs with internal thread	Ball knobs stainless steel or aluminium DIN 319
06240-10 Page 763	06250 Page 772
Mushroom knobs internal thread	Ball knobs smooth DIN 319 enhanced
06240-11 Page 763	06251 Page 774
Mushroom knobs external thread	Tapered knobs
06241 Page 764	06252 Page 774
Mushroom knobs internal thread	Conical knobs

norelem positions
Flexible standard component system

06253
Page 775

Five lobe grips

06255
Page 776

Handwheels 2-spoke plastic

06255
Page 777

Handwheels 2-spoke plastic, with revolving grip

06255
Page 778

Handwheels 2-spoke plastic, with folding grip

06262
Page 779

Handwheels

06263
Page 780

Handwheels with revolving grip

06264
Page 781

Handwheels with fold-away grip

06265
Page 783

Handwheels with safety grip

06266
Page 784

Knurled knobs

06267
Page 786

Knurled knobs metal parts stainless steel

06268
Page 788

Knurled knobs with grip

06271
Page 790

Handwheels DIN 950, grey cast iron

06273
Page 792

Handwheels DIN 950, aluminium

06274
Page 794

Handwheels DIN 950, stainless steel

06275
Page 796

Handwheels disc aluminium

06275
Page 798

Handwheels disc aluminium

06276-01
Page 800

Handwheels disc stainless steel with revolving grip

06277
Page 802

Handwheels 2-spoke aluminium, flat wheel rim

06277
Page 804

Handwheels 2-spoke flat rim, aluminium

06279
Page 806

Handwheels disc similar to DIN 950, aluminium

06287
Page 807

Handwheels disc with revolving grip

06288
Page 808

Handwheels disc without grip

06289
Page 809

Hand wheels, steel, stamped

06290
Page 810

Machine handles fixed steel, similar to DIN 39

06291
Page 810

Machine handles fixed steel, DIN 39 Form E

06292
Page 811

Machine handles fixed aluminium, DIN 39 Form E

06293
Page 811

Machine handles, fixed, DIN 39 Form E, stainless steel

06000

06308
Page 812

Machine handles revolving similar to DIN 98 Form E, steel

06309
Page 812

Machine handles revolving aluminium, similar to DIN 98 Form E

06309-01
Page 813

Machine handles revolving similar to DIN 98 Form E, stainless steel

06310
Page 814

Machine handles revolving steel, similar to DIN 98

06311
Page 814

Machine handles fixed straight form, similar to DIN 39

06312
Page 815

Machine handles revolving straight form, similar to DIN 98

06313
Page 815

Machine handles revolving

06314
Page 816

Conical grip revolving

06315
Page 816

Taper grips fixed

norelem positions
Flexible standard component system

06316
Page 817

Taper grips revolving

06316
Page 817

Taper grips revolving

06317
Page 818

Cylindrical grips revolving stainless steel

06318
Page 818

Conical grips revolving

06319
Page 819

Taper grips

06320
Page 820

Taper grips

06321
Page 821

Cylindrical grips revolving with hexagon socket

06322
Page 821

Cylindrical grips revolving

06323
Page 822

Tension levers

06325-01
Page 823

Cylindrical grips, plastic revolving

06326-01
Page 824

Cylindrical grips, plastic fold-down

06328-01
Page 825

Safety cylindrical grips, plastic auto-return

06330
Page 826

Levers 20° DIN 99

06340
Page 827

Tension lever

06341
Page 828

Tension levers stainless steel

06342
Page 829

Tension levers flat

06349
Page 830

Lock grips

06350
Page 830

Tension levers external thread, stainless steel

06353
Page 831

Ball grips revolving

06355
Page 832

Handles screw-in

06357
Page 832

Handles screw-in with torque limit

06360
Page 833

Handles

06362
Page 834

Clamp hubs

06370
Page 835

Tension levers internal thread

06371
Page 836

Tension levers internal thread, stainless steel

06380
Page 837

Tension levers external thread

06381
Page 838

Tension levers external thread, stainless steel

06000

06382
Page 839

Tension levers safety internal thread

06383
Page 840

Tension levers safety external thread

06390
Page 841

Tension levers flat internal thread

06391
Page 842

Tension levers flat internal thread, stainless steel

06400
Page 843

Tension levers flat external thread

06401
Page 844

Tension levers flat external thread, stainless steel

06410
Page 845

Clamping levers internal thread

06411
Page 846

Clamping levers internal thread, steel parts stainless steel

06420
Page 847

Ball handles DIN 6337

+ New/Expanded Items

+ New/Expanded Items

norelem positions
Flexible standard component system

06430
Page 847

Clamping levers
external thread, steel parts stainless steel

06430
Page 848

Clamping levers with protective cap with internal thread, steel parts stainless steel

06431
Page 849

Clamping levers with protective cap with external thread, steel parts stainless steel

06440
Page 850

Clamping levers with internal thread, steel

06440
Page 851

Clamping levers, zinc with internal thread, steel parts trivalent blue passivated

06441
Page 852

Clamping levers, zinc with female thread and clamping force intensifier

06441
Page 853

Clamping levers, zinc with external thread, steel parts trivalent blue passivated

06442
Page 854

Clamping levers, zinc with male thread and clamping force intensifier

06443
Page 855

Clamping levers, zinc with female thread and clamping force intensifier

06448
Page 856

Clamping levers with protective cap with internal thread, stainless steel

06449
Page 857

Clamping levers with protective cap with external thread, stainless steel

06450
Page 858

Clamping levers, zinc with internal thread, steel parts trivalent blue passivated

06450
Page 859

Clamping levers, zinc with external thread, steel parts trivalent blue passivated

06450-05
Page 860

Clamping levers, zinc with female thread and clamping force intensifier

06450-10
Page 863

Clamping levers, zinc with male thread and clamping force intensifier

06451
Page 864

Clamping levers, zinc with external thread, steel parts trivalent blue passivated

06451
Page 865

Clamping levers, zinc with male thread and clamping force intensifier

06451-10
Page 867

Clamping levers, zinc with female thread and clamping force intensifier

06454
Page 868

Clamping levers with protective cap with internal thread, stainless steel

06454
Page 869

Clamping levers with protective cap with external thread, stainless steel

06458
Page 871

Clamping levers, zinc with internal thread, steel parts trivalent blue passivated

06459
Page 872

Clamping levers, zinc with external thread, steel parts trivalent blue passivated

06460
Page 873

Clamping levers, zinc with female thread and clamping force intensifier

06460
Page 874

Clamping levers, zinc with male thread and clamping force intensifier

06460-05
Page 875

Clamping levers, zinc with external thread, steel parts trivalent blue passivated

06460-10
Page 877

Clamping levers, zinc with female thread and clamping force intensifier

06461
Page 878

Clamping levers, zinc with external thread, steel parts trivalent blue passivated

06000

06461
Page 879

Clamping levers with protective cap with external thread, metal parts stainless steel

06461-10
Page 881

Clamping levers, zinc with male thread and clamping force intensifier

06464
Page 882

Clamping levers with external thread, stainless steel

06464
Page 883

Clamping levers with protective cap with external thread, stainless steel

06470
Page 885

Ratchet levers

06480
Page 887

Crank handles offset similar to DIN 468

06490
Page 888

Crank handles straight similar to DIN 469

06492
Page 889

Crank handles aluminium

06500
Page 890

Crank handles with fold-away grip

norelem positions
Flexible standard component system

06500
Page 891

Crank handles with revolving grip

06502
Page 892

Crank handles aluminium cylindrical revolving grip

06503
Page 893

Crank handles aluminium with safety cylinder grip

06503
Page 894

Crank handles aluminium with fold-away cylinder grip

06504
Page 895

Crank handles aluminium with safety cylinder grip

06505
Page 896

Crank handles stainless steel cylindrical revolving grip

06510
Page 897

Crank handles balanced

06550
Page 897

Bar knobs

06600
Page 898

Clamping levers with plastic handle internal thread

06600
Page 899

Clamping levers with push button internal thread

06600
Page 900

Clamping levers antistatic internal thread, plastic grip

06600-05
Page 901

Clamping levers, plastic with internal thread, steel parts trivalent blue passivated

06600-10
Page 903

Clamping levers, plastic with female thread and clamping force intensifier

06601
Page 904

Clamping levers with plastic handle internal thread, metal parts stainless steel

06601
Page 905

Clamping levers with push button internal thread, metal parts stainless steel

06601-10
Page 907

Clamping levers, plastic with female thread and clamping force intensifier

06610
Page 908

Clamping levers with plastic handle external thread

06610
Page 909

Clamping levers with push button external thread

06610
Page 910

Clamping levers antistatic external thread, plastic grip

06610-05
Page 911

Clamping levers, plastic with external thread, steel parts trivalent blue passivated

06610-10
Page 913

Clamping levers, plastic with male thread and clamping force intensifier

06611
Page 914

Clamping levers with plastic handle external thread, metal parts stainless steel

06611
Page 915

Clamping levers with push button external thread, metal parts stainless steel

06611-10
Page 917

Clamping levers, plastic with male thread and clamping force intensifier

06612
Page 919

Clamping levers with thrust pad

06613-10
Page 920

Clamping levers, plastic with safety function with female thread

06613-11
Page 921

Clamping levers, plastic with safety function with male thread

06000

06620
Page 923

Clamping joints

06621
Page 924

Clamping joints individually adjustable

06622
Page 925

Multiple connectors

06648
Page 926

T-grips stainless steel

06649
Page 927

T-grips

06650
Page 928

T-grips

06651
Page 929

Wing grips internal thread, stainless steel

06652
Page 930

Wing grips

06652
Page 931

Wing grips with tapped through bush

+ New/Expanded Items

+ New/Expanded Items

norelem positions
Flexible standard component system



06651-03
Page 932
Wing nuts narrow in Hygienic DESIGN +



06652
Page 934
Wing grips antistatic



06652
Page 935
Wing grips "Miniwing"



06652
Page 936
Wing grips "Miniwing" with tapped through bush



06652
Page 937
Wing grips "Miniwing" antistatic



06660
Page 938
Wing grips one-sided



06665
Page 939
Wing grips



06666
Page 940
Grip nuts



06666
Page 941
Grip screws



06699
Page 942
Triangular grips



06702
Page 943
Triangular grips with high collar



06830
Page 944
Handwheels



06850
Page 945
Bouton aster



06851
Page 946
Five lobe grips with internal thread



06851-01
Page 947
Five lobe grips with external thread



06852
Page 948
Five lobe grips plastic lockable +



06853
Page 949
Five lobe grips



06895
Page 950
Pull handles



06900
Page 950
Pull handles



06900
Page 951
Pull handles



06901
Page 951
Pull handles



06901-01
Page 952
Pull handles, plastic oval +



06902
Page 953
Pull handles arch



06903
Page 954
Pull handles +



06903
Page 955
Pull handles high temperature resistant +



06903
Page 956
Pull handles stainless steel +



06904
Page 957
Pull handles antistatic +

06000



06907
Page 958
Pull handles arch



06909
Page 959
Pull handles arch



06910
Page 959
Pull handles



06911
Page 960
Pull handles arch



06912
Page 960
Pull handles oblique



06913
Page 961
Pull handles with soft inner face



06914
Page 962
Pull handles stainless steel



06915
Page 962
Pull handles



06916
Page 963
Pull handles

norelem positions
Flexible standard component system



06916-01
Page 964
Pull handles



06916-01
Page 965
Pull handles high temperature resistant



06917
Page 966
Pull handles round



06918
Page 967
Pull handles oval



06919
Page 968
Pull handles oval



06920
Page 969
Pull handles round



06920
Page 970
Pull handles oval



06920
Page 971
Pull handles oval detachable



06921
Page 973
Pull handles



06922
Page 973
Pull handles stainless steel



06923
Page 974
Pull handles angled



06924
Page 974
Pull handles stainless steel



06925
Page 975
Pull handles tubular



06926
Page 975
Pull handles tubular



06927
Page 976
Pull handles tubular



06928
Page 977
Pull handles tubular



06929
Page 978
Pull handles tubular oblique



06930
Page 979
Pull handles high-gloss chromed



06931
Page 980
Pull handles stainless steel



06932
Page 981
Pull handles



06932
Page 982
Pull handles



06933
Page 983
Pull handles



06933
Page 983
Pull handles



06934
Page 984
Pull handles fold-down



06935
Page 985
Pull handles tubular angled



06936
Page 985
Pull handles tubular angled



06937
Page 986
Pull handles tubular

06000



06938
Page 986
Pull handles tubular



06938-01
Page 987
Tubular handles round, aluminium +



06938-02
Page 988
Tubular handles oval, aluminium +



06939
Page 989
Pull handles tubular



06940
Page 990
Pull handles tubular



06941
Page 991
Pull handles tubular



06942
Page 992
Pull handles tubular



06943
Page 993
Pull handles tubular



06944
Page 994
Pull handles tubular stainless steel

+ New/Expanded Items

+ New/Expanded Items

norelem positions

Flexible standard component system



Pull handles angled



Pull handles tubular adjustable



Recessed handles fold-down stainless steel



Tubular handles "Bighand"

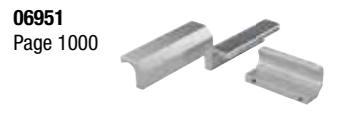

Ledge handles stainless steel

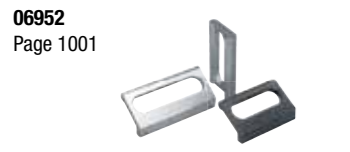

Ledge handles



Tubular handles angled



Pull handles open-ended screw on



Recessed handles



Recessed handles fold-down



Recessed handles fold-down stainless steel



Recessed handles fold-down



Recessed handles



Recessed grips clip-in

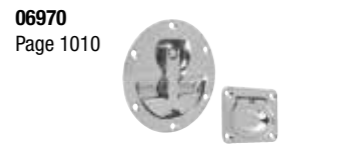

Recessed handles fold-down stainless steel



Recessed handles, fold down DIN 3136



Pull handles angled

Fasteners
Ball-end thrust screws
Thrust screws and thrust pads
Grippers
Torque bolts
Threaded inserts
Lifting bolts
Swivel bales
Ring bolts

07000



07020 Page 1015



Studs 07030 Page 1016



Studs DIN 6379



07040 Page 1018



T-slot bolts DIN 787

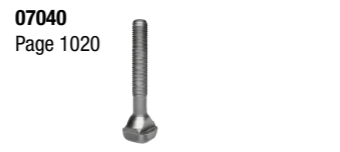

07040 Page 1020



T-slot bolts DIN 787, 12.9



07060 Page 1021

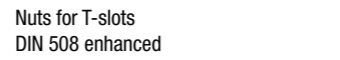

Nuts for T-slots DIN 508 enhanced

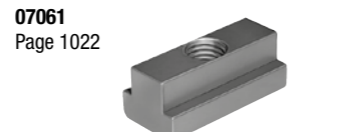

07061 Page 1022



Nuts for T-slots long



07070 Page 1022

Nuts for T-slots blanks



07071 Page 1023

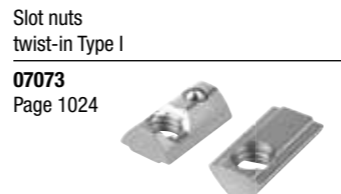

Slot nuts twist-in Type I 07073 Page 1024

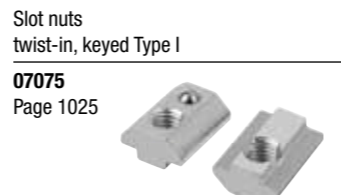

Slot nuts twist-in, keyed Type I 07075 Page 1025

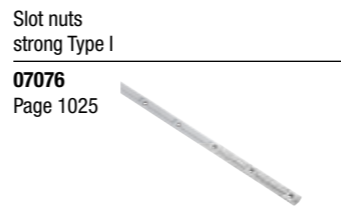

Slot nuts strong Type I 07076 Page 1025



Slot key profile type I 07077 Page 1026

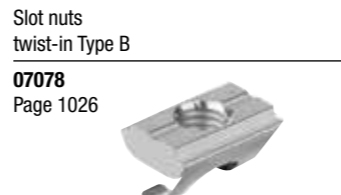

Slot nuts twist-in Type B 07078 Page 1026

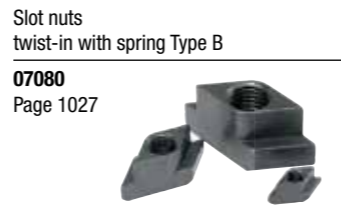

Slot nuts twist-in with spring Type B 07078 Page 1026

Nuts for T-slots rhombic form 07080 Page 1027

norelem positions

Flexible standard component system



T-nuts 07090 Page 1028



Hammer-head screws 07100 Page 1030



Ball-end thrust screws with head 07101 Page 1032



Ball-end thrust screws with head stainless steel 07105 Page 1033



Ball-end thrust screws without head with full ball, LONG-LOK secured 07105 Page 1034



Ball-end thrust screws without head with flattened ball LONG-LOK secured 07109 Page 1035



Ball-end thrust screws without head short version 07110 Page 1036



Ball-end thrust screws without head with full ball 07110 Page 1039

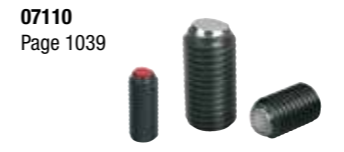

Ball-end thrust screws without head with flattened ball 07110 Page 1039



Ball-end thrust screws without head with flattened ball and rotation lock 07110 Page 1040



Ball-end thrust screws without head stainless steel with full ball 07111 Page 1041



Ball-end thrust screws without head stainless steel with flattened ball 07111 Page 1042



Ball-end thrust screws without head stainless steel with flattened ball and rotation lock 07111 Page 1043



Gripper pads round carbide 07112 Page 1044

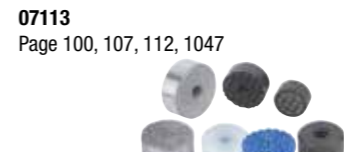

Grippers and inserts round 07113 Page 100, 107, 112, 1047



Grippers and inserts round with counterbore 07113 Page 1048



Grippers hexagonal 07114 Page 1049



Grippers square 07115 Page 1050

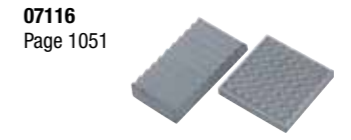

Gripper pads square carbide 07116 Page 1051



Grippers adjustable 07117 Page 1052



Thrust screws 07119 Page 1053



Thrust screws stainless steel 07119 Page 1054



Grub screws with thrust point DIN 6332 07120 Page 1056



Grub screws with thrust point DIN 6332 07121 Page 1056



Grub screws with ball thrust point 07122 Page 1057



Thrust screws with point 07123 Page 1058

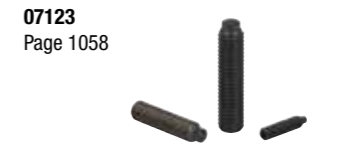

Thrust screws with radiused half-dog point 07123 Page 1058

07000



Torque grips precision version 07124 Page 1059



Knurled torque knobs 07125 Page 1060



Triangular torque grips 07126 Page 1061



Torque screws with thrust point 07130 Page 1062



Torque screws with slot coupling 07131 Page 1062



Torque screws with support pin 07132 Page 1063



Torque grips 07133 Page 1063



Torque screws with ball thrust points 07134 Page 1064

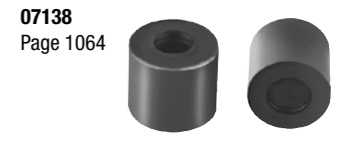

Thrust pads 07138 Page 1064

+ New/Expanded Items

+ New/Expanded Items

norelem positions
Flexible standard component system



07140
Page 1065



Thrust pads
DIN 6311 enhanced



07141
Page 1065



Thrust pads
with retaining pin



07142
Page 1066



Thrust spindles



07143
Page 1067



Swivel feet



07159
Page 1069



Socket head screws
full thread, DIN 912 / DIN EN ISO 4762

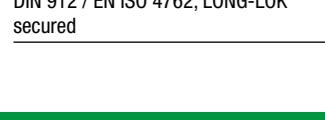

07160
Page 1070

Socket head screws
DIN 912 / DIN EN ISO 4762, steel or stainless steel



07161
Page 1075



Socket head screws
low head DIN 6912



07165
Page 1076



Grub screws with flat point
hexagon socket DIN 913



07166
Page 1077



Grub screw with hexagon socket and
pointed end
DIN 914 / DIN EN ISO 4027



07170
Page 1078

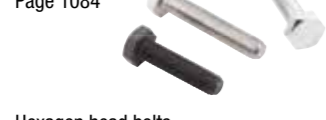

Hexagon head bolts
DIN 931/DIN EN ISO 4014/DIN EN 24014



07170-02
Page 1080



Hexagon bolts with narrow shaft
in Hygienic DESIGN

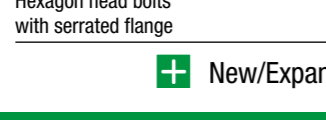

07170-15
Page 1082

Hexagon head screws,
stainless steel
in Hygienic DESIGN



07171
Page 1084



Button head screws
full thread, DIN 912 / DIN EN ISO 4762



07171
Page 1084



Screws with countersunk head
hexagon socket DIN 913

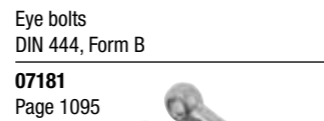

07171
Page 1084

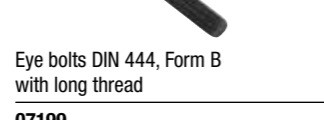

Ball head screw
in Hygienic DESIGN



07170
Page 1078



Eye bolts
DIN 444, Form B



07180
Page 1093



Eye bolts
DIN 444, Form B
with long thread

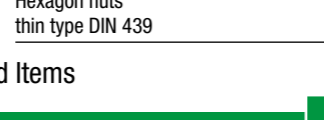

07199
Page 1096

Wing screws



07213
Page 1100



Hexagon nuts with polyamide thread lock
high type, DIN 982 / stainless steel similar
to DIN 982



07214
Page 1101

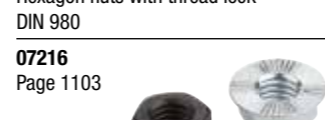

Hexagon nuts with polyamide thread lock
thin type, DIN 985



07215
Page 1102



Hexagon nuts with thread lock
DIN 980



07216
Page 1103



Hexagon nut
with serrated flange



07217
Page 1104



Hexagon nuts with flange
EN 1661



07218
Page 1105

Hexagon nuts with flange

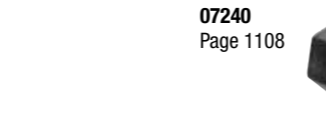

07280
Page 1112

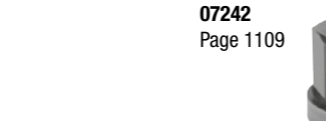

Hexagon domed cap nuts
similar to DIN 1587

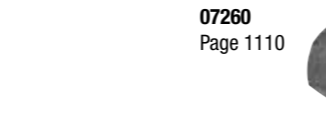

07280-04
Page 1113

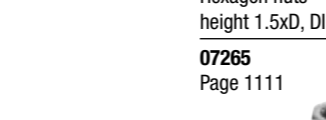

Cap nut compact
in Hygienic DESIGN

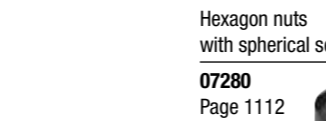

07300
Page 1114

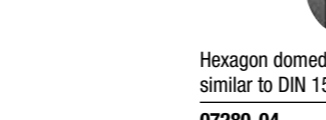

Washers
medium DIN EN ISO 7089 A

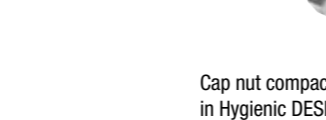

07303
Page 1115

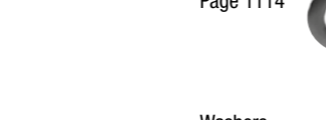

Conical spring washers
DIN 6796

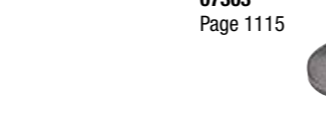

07304
Page 1116

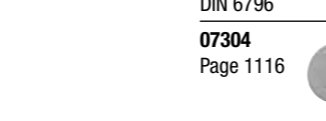

Spring washers
thin type DIN 137 B

norelem positions
Flexible standard component system



07240
Page 1108

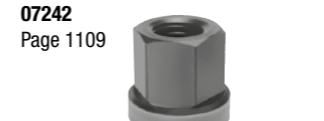

Hexagon nuts with collar
height 1.5xD, DIN 6331 enhanced



07242
Page 1109



Hexagon nuts
with no-loss washer

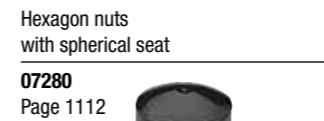

07260
Page 1110

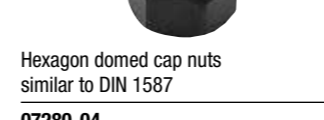

Hexagon nuts
with spherical seat

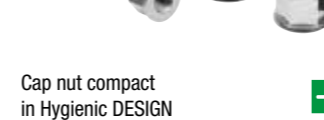

07265
Page 1111



Hexagon nuts
with serrated flange



07280
Page 1112



Hexagon nuts with flange
EN 1661



07305
Page 1117



Washers large OD
DIN 9021



07306
Page 1118



Washers plastic
captive

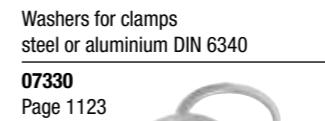

07310
Page 1119

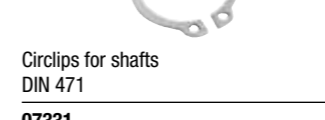

Wedge lock washers
DIN 25201

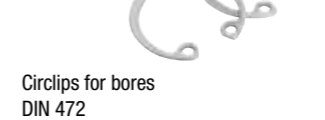

07320
Page 1121



Washers for clamps
steel or aluminium DIN 6340



07330
Page 1123

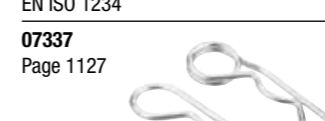

Circlips for shafts
DIN 471



07331
Page 1124

Circlips for bores
DIN 472



07360
Page 1128



Disc springs
DIN EN 16983



07375
Page 1129

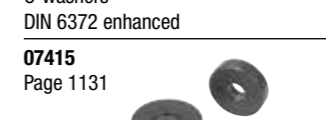

Handwheel washers

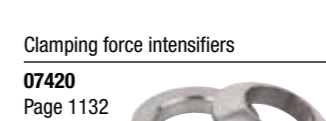

07380
Page 1130



C-washers
DIN 6372 enhanced



07415
Page 1131



C-washers captive
DIN 6371



07460
Page 1134



Spherical washers
DIN 6319, edition 10/01

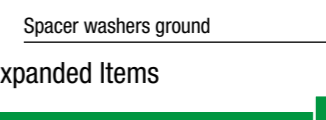

07520
Page 1134

Spherical levelling washers



07530
Page 1136



Shoulder screws with slotted flat head
DIN 923

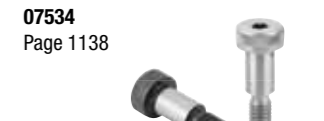

07533
Page 1137



Shoulder screws Form B

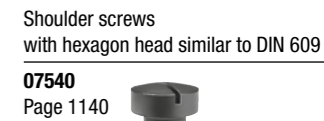

07534
Page 1138

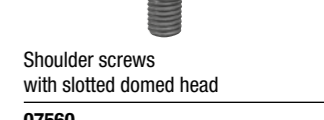

Shoulder screws
similar to DIN ISO 7379

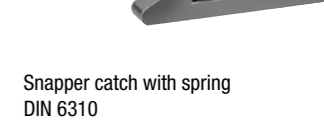

07535
Page 1139



Shoulder screws
with hexagon head similar to DIN 609



07540
Page 1140



Shoulder screws
with slotted domed head



07560
Page 1140

Snapper catch with spring
DIN 6310

+ New/Expanded Items

+ New/Expanded Items

norelem positions
Flexible standard component system

07590-02
Page 1146



Locking plate steel or stainless steel
DIN 5406 +

07590-05
Page 1148



Slotted round nuts, steel,
DIN 70852 +

07595
Page 1149



Slotted nuts
with elastic lock

07598
Page 1150-1151



Adjustment nuts

07620
Page 1152



Clevis
with external thread

07630
Page 1152



Grub screws
DIN 551

07640
Page 1154



Threaded rods
steel and stainless steel DIN 976-1

07650
Page 1156

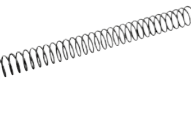

Springs
for clamp straps

07645
Page 1157



HeliCoil®plus threaded inserts

07652
Page 1159



Threaded inserts self-tapping
with cutting slot

07652
Page 1159-1161



Assembly tools
for self-tapping threaded inserts

07653
Page 1161



Threaded inserts self-tapping
with cutting bores

07660
Page 1162



Threaded inserts

07661
Page 1163



Threaded inserts reinforced

07662
Page 1164



Threaded inserts solid body

07663
Page 1165



Threaded inserts with internal thread,
self-locking

07664
Page 1166



Threaded inserts reinforced
internal thread, self-locking

07666
Page 1167



Repair kit

07670
Page 1169



Studs
with screw-in stop for gluing in

07680
Page 1171



Ring bolts
DIN 580 +

07680-01
Page 1172



Ring bolts
similar to DIN 580

07690
Page 1173



Ring nuts
DIN 582 +

07690-01
Page 1174



Ring nuts
similar to DIN 582

07695
Page 1175



Ring bolts rotatable
high-strength grade 10

07710
Page 1176



Ring bolts
swivel and 360° rotatable, grade 8

07715
Page 1177



Bow shackles

07716
Page 1178



D-shackles

07000

07720
Page 1179



Weld-on D-rings

07725
Page 1180



Hoist rings 360° rotation
grade 10

07730
Page 1181



Hoist rings

07735
Page 1182



Hoist rings with Envirolox® coating

07750
Page 1182



Lifting rings

07752
Page 1183



Swivel bales
with axial ring

07770
Page 1184



Hoist rings

07772
Page 1185



Flip-Flop hoist rings

07774
Page 1186



Hoist rings

norelem positions
Flexible standard component system

07775
Page 1187



Swivel bales

07780
Page 1188



Lifting pins
self-locking

07780
Page 1189



Lifting pins
self-locking, stainless steel

07781
Page 1190



Receiver bushes
for ball lifting pins, stainless steel

07781
Page 1191



Locating bushes
for ball lifting pins stainless steel, flat

07782
Page 1192



Lifting pins
self-locking, stainless steel +

07784
Page 1193



Receiver bush
stainless steel, for lifting pins

07791
Page 1195



Slip hooks
grade 10

07792
Page 1196



Self-locking hooks
grade 10

07793
Page 1197



Shortening hooks
grade 10

07794
Page 1198



Swivel hooks
grade 10

07795
Page 1199



Connecting links
grade 10

07796
Page 1200



Round sling hooks
grade 8

07797
Page 1201



Round sling links
grade 8

07798
Page 1202



Round slings +

07798-02
Page 1203



Lifting slings +

07800
Page 1204



Shaft collars set screw
DIN 705, steel

07800
Page 1206



Shaft collars set screw
DIN 705, stainless steel

07000

07810
Page 1207



Shaft collars one-piece

07810
Page 1208



Shaft collars
one-piece, with clamping lever

07811
Page 1209



Shaft collars one-piece
wide

07812
Page 1210



Shaft collars two-piece

07813
Page 1211



Shaft collars two-piece
wide

07814
Page 1212



Shaft collars
with thread

07820
Page 1215







Ratchet elements
steel or stainless steel +





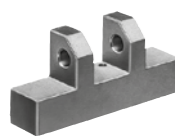





+ New/Expanded Items

+ New/Expanded Items

norelem positions
Flexible standard component system



- 08050**
Page 1218

Hinge blocks long
- 08100**
Page 1218

Hinge blocks long
- 08150**
Page 1219

Hinge blocks short
- 08180**
Page 1220

Latch
- 02010**
Page 114, 1220

Thrust washers
- 08570**
Page 1221

Rest pads
- 08580**
Page 1222

Drilling plates
DIN 6348 enhanced
- 08050**
Page 1218

Hinge blocks short
- 08600**
Page 1223

Extension columns short
- 08610**
Page 1223

Extension columns short
- 08900**
Page 1224

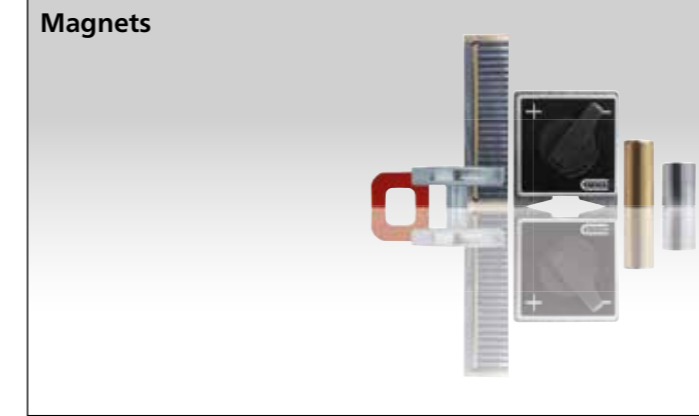
Extension columns long
- 08910**
Page 1225

Drill bushes cylindrical
DIN 179
- 08920**
Page 1226

Drill bushes flanged
DIN 172
- 08920**
Page 1227
Page

Drill bushes push-in
DIN 173
- 08920**
Page 1227
Page

Drill bushes push-in
DIN 173-1
- 08926**
Page 1228

Drill bush clamps
DIN 173-1



Shoulder screws flathead for DIN 173 drill bushes

08000

norelem positions
Flexible standard component system



- 09000**
Page 1232

Magnets raw
NdFeB, disc form
- 09001**
Page 1232

Magnets raw with hole
NdFeB, disc form
- 09002**
Page 1233

Magnets raw
NdFeB, block form
- 09003**
Page 1233

Magnets raw
AlNiCo, bar type
- 09060**
Page 1234

Permanent workholding magnets
with fine pole division
- 09060**
Page 1235

Magnets deep pot
AlNiCo with fitting tolerance
- 09061**
Page 1235

Magnets deep pot
AlNiCo without fitting tolerance
- 09063**
Page 1236

Magnets deep pot with pin
AlNiCo
- 09064**
Page 1236

Magnets shallow pot
hard ferrite
- 09065-10**
Page 1237

Magnets shallow pot with thread
hard ferrite
- 09065-10**
Page 1237

Magnets shallow pot with internal thread
hard ferrite with stainless-steel housing
- 09066**
Page 1238

Magnets shallow pot
SmCo
- 09067**
Page 1238

Magnets deep pot
SmCo
- 09067-10**
Page 1239

Magnets deep pot
NdFeB
- 09067-11**
Page 1240

Magnets
deep pot with machinable magnetic face
NdFeB
- 09068**
Page 1241

Magnets deep pot with internal thread
NdFeB
- 09069**
Page 1242

Magnets shallow pot
NdFeB
- 09069-10**
Page 1243

Magnets shallow pot with hook
NdFeB
- 09070**
Page 1244

Magnets shallow pot with counterbore
hard ferrite
- 09070-10**
Page 1244

Magnets shallow pot with counterbore
SmCo with stainless-steel housing
- 09071**
Page 1245

Magnets shallow pot with countersink
hard ferrite
- 09071-10**
Page 1245

Magnets shallow pot with countersink
hard ferrite with stainless-steel housing
- 09071-20**
Page 1246

Magnets shallow pot with countersink
SmCo
- 09071-30**
Page 1246

Magnets shallow pot with countersink
NdFeB
- 09072**
Page 1247

Magnets shallow pot with internal thread
NdFeB
- 09072-10**
Page 1247

Magnets shallow pot with internal thread
hard ferrite
- 09094**
Page 1248

Magnets deep pot
- 09096**
Page 1248

Magnets shallow pot
- 09098**
Page 1249

Magnets button
- 09100**
Page 1249

Magnets strong
- 09110**
Page 1250

Protective rubber caps
for shallow pot magnets
- 09112**
Page 1250

Magnets shallow pot with internal thread
NdFeB, with rubber protective jacket

+ New/Expanded Items

+ New/Expanded Items

norelem positions
Flexible standard component system

09000

09112-10
Page 1251



Magnets with internal thread NdFeB, rectangular, with rubber protective jacket

09114
Page 1252



Magnets shallow pot with tapped pin NdFeB, with rubber protective jacket

09116
Page 1252



Magnets shallow pot with threaded pin NdFeB, with rubber protective jacket

09117
Page 1253



Magnets deep pot with threaded pin NdFeB, rubber magnetic face

09118
Page 1253



Magnets shallow pot with through hole NdFeB, with rubber protective jacket

09119
Page 1254



Retaining magnets hard ferrite

09119-10
Page 1254



Retaining magnets hard ferrite

09150
Page 1255



Magnetic Pickup

09210
Page 1255



Magnetic base, permanent

09230
Page 1256



Magnetic clamping balls **+**

norelem assemblies
Assembly system

10000

Aluminium profiles
Connectors
Covers
Special elements

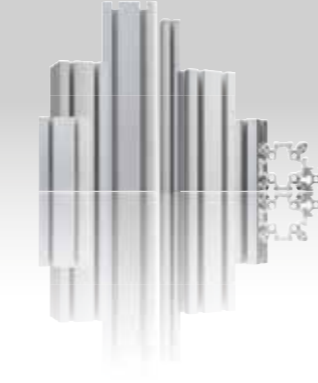

10025
Page 1259



Aluminium profiles 30x30 light Type I

10025
Page 1259

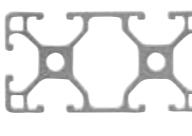

Aluminium profiles 30x60 light Type I

10025
Page 1260



Aluminium profiles 60x60 light Type I

10045
Page 1261



Aluminium profiles 40x40 light Type I

10045
Page 1261



Aluminium profiles 40x80 light Type I

10045
Page 1262



Aluminium profiles 80x80 light Type I

10048
Page 1263



Aluminium profiles 16x40 Type I

10048
Page 1263



Aluminium profiles 40x40 Type I

10048
Page 1264



Aluminium profiles 40x80 Type I

10048
Page 1264



Aluminium profiles 80x80 Type I

10050
Page 1265



Aluminium profiles D50 Type I, tube

10051
Page 1265



Aluminium profiles 40x40 for roller rails, Type I

10140
Page 1266



Aluminium profiles 30x30 Type B

10140
Page 1266



Aluminium profiles 30x60 Type B

norelem assemblies
Assembly system

10142
Page 1267



Aluminium profiles 40x40 light Type B

10142
Page 1267



Aluminium profiles 40x80 light Type B

10157
Page 1268



Aluminium profiles 45x45 light Type B

10157
Page 1268



Aluminium profiles 45x90 light Type B

10157
Page 1269

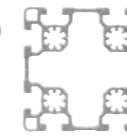

Aluminium profiles 90x90 light Type B

10160
Page 1270



Aluminium profiles 45x45 Type B

10160
Page 1270



Aluminium profiles 45x60 Type B

10160
Page 1271



Aluminium profiles 45x90 Type B

10160
Page 1271



Aluminium profiles 90x90 Type B

10161
Page 1272



Aluminium profiles 40x40 for roller rails, Type B

10200
Page 1273



Connecting sets standard Type I

10202
Page 1274



Connecting sets universal Type I

10204
Page 1275



Connecting sets central Type I

10205
Page 1276



Connecting sets central Type B

10206
Page 1277



Connecting sets central Type B

10210
Page 1278



Connecting sets automatic Type I

10212
Page 1279



Connecting sets automatic Type B

10215
Page 1280



Pin connector sets Type B

10220
Page 1281



Cube connector sets Type B

10228
Page 1282



Central screws Type B

10228-01
Page 1283



Threaded insert, steel, self-tapping, type B **+**

10228-01
Page 1284



Assembly tool, steel, for self-tapping threaded inserts type B **+**

10230
Page 1285



Butt connector sets automatic Type I

10240
Page 1286



Straps Type B

10242
Page 1286



Angles Type I

10244
Page 1287



Fastening sets for straps und angles

10250
Page 1288

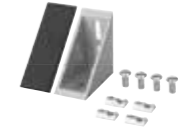

Angle sets Type I

10000

10252
Page 1289

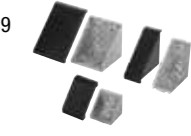

Angle sets Type B

10260
Page 1290



Angle elements T1 Type I

10261
Page 1291



Angle elements T2 Type I

10265
Page 1292



Clamping angles Type I

10266
Page 1293



Joint angles Type I

10270
Page 1295



Joints Type B and Type I

10300
Page 1296

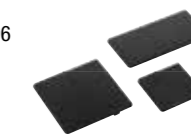

End caps Type B and Type I

10315
Page 1297



Cover and adapter profiles Type B and Type I

10320
Page 1298



Cover profiles Type I

+ New/Expanded Items

+ New/Expanded Items

norelem assemblies

Assembly system



Slide rails
Type I



Foot plates
Type B and Type I



Bearing flange
for feed roller



Plastic roller elements
for roller rails



Stainless steel brakes
for roller elements



Plastic roller elements, compact
for roller rails



Ball transfer units
for roller rails



Brush elements, plastic
for roller rails



Spacers, plastic
for roller rails



Backstop elements, steel
for roller rails



Plastic slide ramps
for roller rails



Plastic slide rails
for roller rails



End plates, steel
for roller rails



Suspension brackets, steel
for roller rails



Mounting brackets, steel
for roller rails



Roller elements



Cable tie block



Cable clips



Cable clips with T-slot key



Sensor holders



Earthing terminal
Type I



Potential equaliser
Type I



Eccentric clamp modules



Cam clamps
for eccentric clamp modules



Clip-in shell bins, plastic
for profile slots type I and type B
and mounting profiles

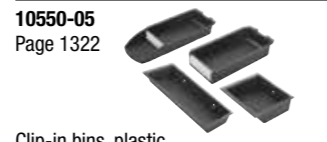

Clip-in bins, plastic
for type I and type B profile slots
and mounting profiles



Clip-in bins, antistatic plastic
for mounting profiles

10000



Swivel adapter, plastic
for profile slots



Swivel adapter, antistatic plastic
for profile slots



Cup holder plastic
for aluminium profiles,
closed or open

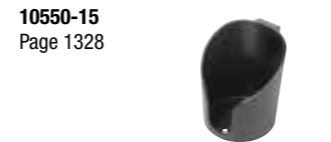

Cup holder plastic, antistatic
for aluminium profiles, closed

norelem assemblies

Pneumatic technology



Pneumatic cylinders
DIN ISO 1552 standard cylinder



Pneumatic compact cylinders
DIN ISO 21287, double-acting with
magnetic piston



Pneumatic round cylinders
DIN ISO 6432, double-acting with
magnetic piston

+ New/Expanded Items

+ New/Expanded Items

Linear modules
Lifting units
Rotary modules
Grip modules

20000
Page 46

Linear modules pneumatic with two round guides

20000
Page 48

Linear modules pneumatic with three round guides

20010
Page 50

Stop screws

20032
Page 52

Linear modules pneumatic with rail guide

20034
Page 54

Linear modules pneumatic with rail guide

20036
Page 56

Linear modules pneumatic with rail guide

20050
Page 60

Lifting units pneumatic with rail guide

20054
Page 62

Lifting units pneumatic with round guides

20056
Page 64

Lifting units pneumatic with round guides

20060
Page 67

Rotary module pneumatic

20060
Page 68

Rotary module pneumatic

20062
Page 69

Rotary module pneumatic

20062
Page 70

Rotary module pneumatic heavy duty version

20064
Page 71

Rotary module pneumatic

20064
Page 72

Rotary module pneumatic heavy duty version

20100
Page 75

Grip module parallel grippers

20200
Page 79

Linear gantry module with rail guides

20200
Page 81

Linear gantry module with round guides

20240
Page 81

Centring rings

20300
Page 83

Linear actuators with toothed belt drive and profile rail guide

20310
Page 84

T-slot tables

20320
Page 85

Motor adapter sets

20321
Page 86

Adapter plates, aluminium

20330
Page 89

Synchronisation sets

20000

Slides
Guide rails
Positioning stages
Linear guide systems
Position indicators

21000
Page 93

Dovetail slides with micrometer spindle

21000
Page 94

Dovetail slides with micrometer spindle

21000
Page 95

Straps

21010
Page 97

Fastening screws for cross table mounting

21010-01
Page 97

Dovetail slides with micrometer spindle and location holes

21030
Page 99

Mounting brackets

21031
Page 100

Dovetail slides with end plates

21032
Page 101

Dovetail slides with micrometer spindle

21033
Page 102

Dovetail slides with micrometer spindle and handwheel

21034
Page 103

Precision slides roller mounted

21035
Page 104

Slides mini roller mounted

21038
Page 105

Precision slides roller mounted with end plates

21040
Page 106

Precision slides roller mounted with micrometer spindle

21050
Page 107

Guide rails for cross rollers

21052
Page 108

Roller cages for guide rails

21054
Page 111

Guide rails Teflon-coated

21060
Page 113

Dovetail slides with location holes

21061
Page 115

Dovetail slides with end plates and location holes

21062
Page 117

Dovetail slides with micrometer spindle and location holes

21064
Page 119

Precision slides roller mounted with location holes

21068
Page 121

Precision slides roller mounted with end plates and location holes

21070
Page 123

Precision slides roller mounted with micrometer spindle and location holes

21080
Page 124

Positioning stages short with coaxial electric drive

21081
Page 126

Positioning stages short with lateral electric drive

21082
Page 128

Positioning stages long with coaxial electric drive

21083
Page 130

Positioning stages long with lateral electric drive

21085
Page 132

Positioning stages rotary with coaxial electric drive

21085-01
Page 136

Rotary stages with coaxial electric drive, high load

21090
Page 138

Mounting plates horizontal

21091
Page 140

Mounting plates vertical

21093
Page 142

Sensor holder

21094
Page 143

Sensor holder

21000

+ New/Expanded Items

+ New/Expanded Items



21100
Page 145



21102
Page 146

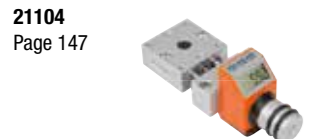

21104
Page 147



21120
Page 148



21122
Page 149



21124
Page 149



21130
Page 152



21132
Page 153



21133
Page 155



21134
Page 156



21136
Page 158



21137
Page 159



21138
Page 160



21139
Page 161



21140
Page 162

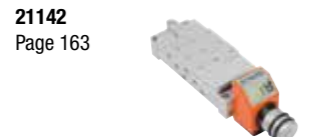

21142
Page 163



21150
Page 164



21160
Page 165



21161
Page 166

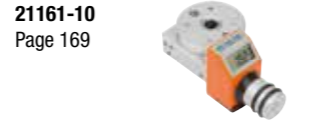

21161-10
Page 169



21162
Page 170



21170
Page 171



21180
Page 172



21190
Page 173



21200
Page 176



21200
Page 177



21210
Page 179

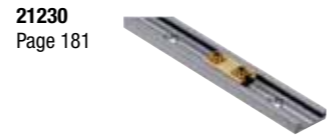

21230
Page 181

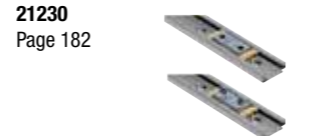

21230
Page 182



21230
Page 183

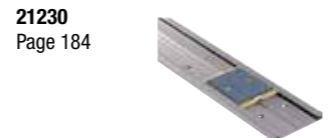

21230
Page 184



21240
Page 185



21240
Page 186

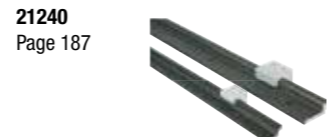

21240
Page 187



21240
Page 188



21240
Page 189

21000



21245-01
Page 190



21245-01
Page 191



21250
Page 193



21250-01
Page 194



21320
Page 195



21320
Page 196



21322
Page 197



21322
Page 198



21322
Page 199



21330
Page 201

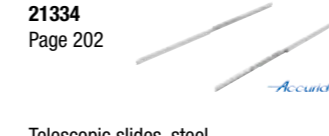

21334
Page 202



21334-05
Page 204



21334-10
Page 206



21334-15
Page 210



21334-20
Page 215



21334-25
Page 217



21334-30
Page 219



21334-35
Page 220

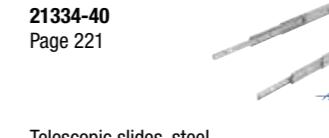

21334-40
Page 221



21334-45
Page 222



21334-50
Page 223



21334-55
Page 224



21334-60
Page 225



21334-65
Page 226



21334-70
Page 227



21334-75
Page 228



21334-80
Page 229



21334-85
Page 230



21334-90
Page 231



21334-95
Page 232



21335
Page 233



21335-05
Page 234



21335-10
Page 235



21335-15
Page 237



21335-20
Page 238

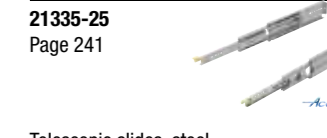

21335-25
Page 241

21000

+ New/Expanded Items

+ New/Expanded Items

norelem moves

Systems and components for machine and plant construction

21923
Page 321



Position indicators
freely programmable

21924
Page 323



Position indicator, plastic, electronic
IO link interface **+**

21924-01
Page 324



Magnetic sensors, passive sensors,
miniature design
IO link interface **+**

21940
Page 327



Reducing bushings

21942
Page 327



Intermediate plates

21944
Page 328



Mounting brackets

21952
Page 329



Adjusting knobs with position indicator
digital display

21962
Page 330



Position indicators for handwheels
analogue-digital display

21972
Page 331



Handwheels for position indicators

21000 / 22000

Drive technology

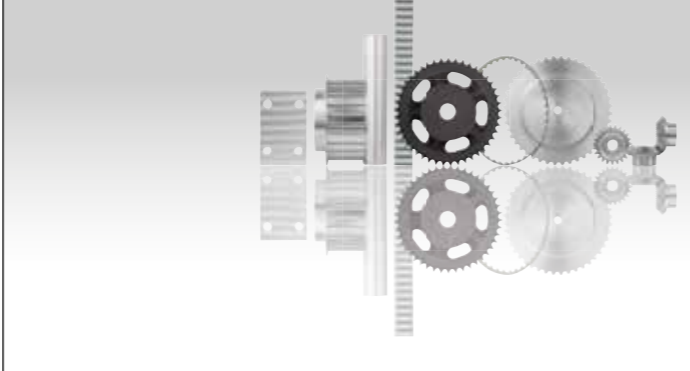

22002
Page 338



Toothed belt pulleys
T profile

22003
Page 340



Toothed belt pulleys
AT profile

22004
Page 342



Toothed pulleys
profile HTD 5M

22004
Page 343



Toothed pulleys
profile HTD 8M

22005
Page 346



Toothed pulleys
profile HTD 5M, for assembly with taper
clamping bushes

22005
Page 348



Toothed pulleys
profile HTD 8M, for assembly with taper
clamping bushes

22007
Page 350



Splined shafts
T profile

22008
Page 351



Splined shafts
AT profile

22012
Page 352

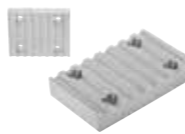

Clamp plates for toothed belts
profile T and AT

22052
Page 353



Toothed belts
T profile

22054
Page 356



Toothed belts by the meter
T profile

22057
Page 358



Toothed belts
AT profile

22059
Page 360



Toothed belts by the meter
AT profile

22062
Page 362



Toothed belt
profile HTD 5M

norelem moves

Systems and components for machine and plant construction

22062
Page 363



Toothed belt
profile HTD 8M

22070
Page 364



V-belt pulleys, grey cast iron
for mounting with taper clamping
bushes **+**

22071
Page 370



V-belts DIN 2215 **+**

22071-02
Page 380



V-belts DIN 7753 **+**

22100
Page 389



Belt tension meter

22101
Page 390



Line laser

22102
Page 391



Tension pulleys

22200
Page 394



Roller chains single
DIN ISO 606, curved link plate **+**

22200
Page 395



Links
DIN ISO 606 **+**

22201
Page 396



Roller chains duplex
DIN ISO 606, curved link plate

22201
Page 397



Connecting links duplex
DIN ISO 606

22202
Page 398



Roller chains triplex
DIN ISO 606, curved link plate

22202
Page 398



Connecting links triplex
DIN ISO 606

22208
Page 399



Roller chains single
DIN ISO 606, straight link plate

22208
Page 399



Links
DIN ISO 606

22212
Page 400



Roller chains single stainless steel
DIN ISO 606, curved link plate

22212
Page 400



Links stainless steel
DIN ISO 606

22213
Page 401



Roller chain duplex, stainless steel
DIN ISO 606, curved link plate **+**

22213
Page 401



Connecting links duplex, stainless steel
DIN ISO 606

22250
Page 402



Sprockets single 3/8" x 7/32"
DIN ISO 606, ready to install

22250
Page 404



Sprockets single 1/2" x 5/16"
DIN ISO 606, ready to install

22250
Page 407



Sprockets single 5/8" x 3/8"
DIN ISO 606, ready to install

22250
Page 410



Sprockets single 3/4" x 7/16"
DIN ISO 606, ready to install

22250
Page 413



Sprockets single 1" x 17.02 mm
DIN ISO 606, ready to install

22252
Page 416



Sprockets single 3/8" x 7/32"
DIN ISO 606

22252
Page 417



Sprockets single 1/2" x 5/16"
DIN ISO 606

22252
Page 418



Sprockets single 5/8" x 3/8"
DIN ISO 606 **+**

22000

22252
Page 419



Sprockets single 3/4" x 7/16"
DIN ISO 606

22252
Page 420



Sprockets single 1" x 17.02 mm
DIN ISO 606

22253
Page 421



Sprockets duplex 8.0 mm x 3.0 mm
DIN ISO 606

22253
Page 422



Sprockets duplex 3/8" x 7/32"
DIN ISO 606

22253
Page 423



Sprockets duplex 1/2" x 5/16"
DIN ISO 606

22253
Page 424



Sprockets duplex 5/8" x 3/8"
DIN ISO 606

22253
Page 425



Sprockets duplex 3/4" x 7/16"
DIN ISO 606

22253
Page 426



Sprockets duplex 1" x 17.02 mm
DIN ISO 606



















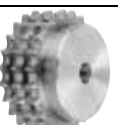













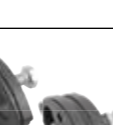

22253
Page 427



























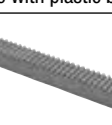







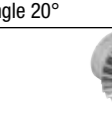

Sprockets duplex 1 1/4" x 3/4"
DIN ISO 606

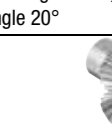
+ New/Expanded Items

+ New/Expanded Items

<p>22253 Page 428</p>  <p>Sprockets duplex 1 1/2" x 1" DIN ISO 606</p>	<p>22255 Page 437</p>  <p>Sprockets single 3/4" x 7/16" stainless steel DIN ISO 606</p>	<p>22265 Page 454</p>  <p>Sprockets duplex 1/2" x 5/16" DIN ISO 606</p>	<p>22266 Page 470</p>  <p>Sprockets triplex 3/4" x 7/16" DIN ISO 606</p>
<p>22254 Page 429</p>  <p>Sprockets triplex 3/8" x 7/32" DIN ISO 606</p>	<p>22255 Page 438</p>  <p>Sprockets single 1" x 17.02 mm stainless steel DIN ISO 606</p>	<p>22265 Page 456</p>  <p>Sprockets, duplex 5/8" x 3/8" DIN ISO 606</p>	<p>22266 Page 472</p>  <p>Sprockets triplex 1" x 17.02 mm DIN ISO 606</p>
<p>22254 Page 430</p>  <p>Sprockets triplex 1/2" x 5/16" DIN ISO 606</p>	<p>22264 Page 440</p>  <p>Sprockets single 3/8" x 7/32" DIN ISO 606</p>	<p>22265 Page 458</p>  <p>Sprockets duplex 3/4" x 7/16" DIN ISO 606</p>	<p>22280 Page 474</p>  <p>Idle sprockets with ball bearing</p>
<p>22254 Page 431</p>  <p>Sprockets triplex 5/8" x 3/8" DIN ISO 606</p>	<p>22264 Page 442</p>  <p>Sprockets single 1/2" x 5/16" DIN ISO 606</p>	<p>22265 Page 460</p>  <p>Sprockets duplex 1" x 17.02 mm DIN ISO 606</p>	<p>22280 Page 476</p>  <p>Mounting screws for idler sprockets</p>
<p>22254 Page 432</p>  <p>Sprockets triplex 3/4" x 7/16" DIN ISO 606</p>	<p>22264 Page 444</p>  <p>Sprockets single 5/8" x 3/8" DIN ISO 606</p>	<p>22265 Page 462</p>  <p>Sprockets duplex 1 1/4" x 3/4" DIN ISO 606</p>	<p>22281 Page 477</p>  <p>Sprocket sets</p>
<p>22254 Page 433</p>  <p>Sprockets triplex 1" x 17.02 mm DIN ISO 606</p>	<p>22264 Page 446</p>  <p>Sprockets single 3/4" x 7/16" DIN ISO 606</p>	<p>22265 Page 463</p>  <p>Sprockets duplex 1 1/2" x 1" DIN ISO 606</p>	<p>22281-01 Page 478</p>  <p>Chain tensioner sets</p>
<p>22255 Page 434</p>  <p>Sprockets single 3/8" x 7/32" stainless steel DIN ISO 606</p>	<p>22264 Page 448</p>  <p>Sprockets single 1" x 17.02 mm DIN ISO 606</p>	<p>22266 Page 464</p>  <p>Sprockets triplex 3/8" x 7/32" DIN ISO 606</p>	<p>22281-10 Page 479</p>  <p>Clamping elements</p>
<p>22255 Page 435</p>  <p>Sprockets single 1/2" x 5/16" stainless steel DIN ISO 606</p>	<p>22265 Page 450</p>  <p>Sprockets duplex 8.0 mm x 3.0 mm DIN ISO 606</p>	<p>22266 Page 466</p>  <p>Sprockets triplex 1/2" x 5/16" DIN ISO 606</p>	<p>22281-14 Page 480</p>  <p>Clamping elements stainless steel</p>
<p>22255 Page 436</p>  <p>Sprockets single 5/8" x 3/8" stainless steel DIN ISO 606</p>	<p>22265 Page 452</p>  <p>Sprockets duplex 3/8" x 7/32" DIN ISO 606</p>	<p>22266 Page 468</p>  <p>Sprockets triplex 5/8" x 3/8" DIN ISO 606</p>	<p>22281-16 Page 481</p>  <p>Clamping elements with front fastening</p>

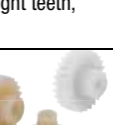















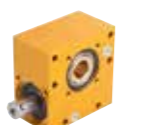

+ New/Expanded Items

<p>22281-20 Page 482</p>  <p>Angle bracket for clamping elements</p>	<p>22400 Page 497</p>  <p>Spur gears in steel, module 4 toothing milled, straight teeth, engagement angle 20°</p>	<p>22402 Page 513</p>  <p>Spur gears, plastic, module 2 injection moulded, straight teeth, engagement angle 20°</p>	<p>22432 Page 524</p>  <p>Bevel gears, plastic, ratio 1:5 injection moulded, straight teeth, engagement angle 20°</p>
<p>22282 Page 483</p>  <p>Glide rails PE-UHMW for roller chains DIN ISO 606</p>	<p>22400 Page 499</p>  <p>Spur gears in steel, module 5 toothing milled, straight teeth, engagement angle 20°</p>	<p>22402 Page 515</p>  <p>Spur gears, plastic, module 2.5 injection moulded, straight teeth, engagement angle 20°</p>	<p>22433 Page 525</p>  <p>Bevel gears, zinc, ratio 1:1 cast, straight teeth, engagement angle 20°</p>
<p>22282-05 Page 484</p>  <p>Glide rails PE-UHMW for roller chains DIN ISO 606 for C profiles</p>	<p>22400 Page 500</p>  <p>Spur gears in steel, module 6 toothing milled, straight teeth, engagement angle 20°</p>	<p>22402 Page 517</p>  <p>Spur gears, plastic, module 3 injection moulded, straight teeth, engagement angle 20°</p>	<p>22715 Page 526</p>  <p>Bevel gear drive with plastic bevel gears</p>
<p>22282-10 Page 485</p>  <p>C profiles steel or stainless steel for glide rails</p>	<p>22400 Page 501</p>  <p>Spur gears in steel, module 8 toothing milled, straight teeth, engagement angle 20°</p>	<p>22422 Page 518</p>  <p>Gear racks, plastic injection moulded, straight teeth, engagement angle 20°</p>	<p>22420 Page 527</p>  <p>Gear racks in steel toothing milled, straight teeth, engagement angle 20°</p>
<p>22400 Page 486</p>  <p>Spur gears in steel, module 1 toothing milled, straight teeth, engagement angle 20°</p>	<p>22402 Page 503</p>  <p>Spur gears, plastic, module 0.5 injection moulded, straight teeth, engagement angle 20°</p>	<p>22432 Page 519</p>  <p>Bevel gears, plastic, ratio 1:1 injection-moulded, straight teeth, engagement angle 20°</p>	<p>22425 Page 528</p>  <p>Gear racks in steel toothing milled, straight teeth, engagement angle 20°</p>
<p>22400 Page 488</p>  <p>Spur gears in steel, module 1.5 toothing milled, straight teeth, engagement angle 20°</p>	<p>22402 Page 505</p>  <p>Spur gears, plastic, module 0.7 injection moulded, straight teeth, engagement angle 20°</p>	<p>22432 Page 520</p>  <p>Bevel gears, plastic, ratio 1:1.5 injection moulded, straight teeth, engagement angle 20°</p>	<p>22430 Page 529</p>  <p>Bevel gears in steel, ratio 1:1 toothing milled, straight teeth, engagement angle 20°</p>
<p>22400 Page 490</p>  <p>Spur gears in steel, module 2 toothing milled, straight teeth, engagement angle 20°</p>	<p>22402 Page 507</p>  <p>Spur gears, plastic, module 1 injection moulded, straight teeth, engagement angle 20°</p>	<p>22432 Page 521</p>  <p>Bevel gears, plastic, ratio 1:2 injection moulded, straight teeth, engagement angle 20°</p>	<p>22430 Page 530</p>  <p>Bevel gears in steel, ratio 1:2 toothing milled, straight teeth, engagement angle 20°</p>
<p>22400 Page 492</p>  <p>Spur gears in steel, module 2.5 toothing milled, straight teeth, engagement angle 20°</p>	<p>22402 Page 509</p>  <p>Spur gears, plastic, module 1.25 injection moulded, straight teeth, engagement angle 20°</p>	<p>22432 Page 522</p>  <p>Bevel gears, plastic, ratio 1:3 injection moulded, straight teeth, engagement angle 20°</p>	<p>22430 Page 531</p>  <p>Bevel gears in steel, ratio 1:3 toothing milled, straight teeth, engagement angle 20°</p>
<p>22400 Page 494</p>  <p>Spur gears in steel, module 3 toothing milled, straight teeth, engagement angle 20°</p>	<p>22402 Page 511</p>  <p>Spur gears, plastic, module 1.5 injection moulded, straight teeth, engagement angle 20°</p>	<p>22432 Page 523</p>  <p>Bevel gears, plastic, ratio 1:4 injection-moulded, straight teeth, engagement angle 20°</p>	<p>22430 Page 532</p>  <p>Bevel gears in steel, ratio 1:4 toothing milled, straight teeth, engagement angle 20°</p>

+ New/Expanded Items

norelem moves

Systems and components for machine and plant construction

<p>22500 Page 537</p>  <p>Worm gears, right-hand centre distance 17 mm</p>	<p>22500 Page 554</p>  <p>Worm gears, right-hand centre distance 63 mm</p>	<p>22750 Page 567</p>  <p>Planetary gearing for stepper motors</p>
<p>22500 Page 539</p>  <p>Worm gears, right-hand centre distance 22.62 mm</p>	<p>22500 Page 556</p>  <p>Worm gears, right-hand centre distance 65 mm</p>	<p>+</p>
<p>22500 Page 541</p>  <p>Worm gears, right-hand centre distance 25 mm</p>	<p>22500 Page 559</p>  <p>Worm gears, right-hand centre distance 80 mm</p>	
<p>22500 Page 542</p>  <p>Worm gears, right-hand centre distance 31 mm</p>	<p>22700 Page 561</p>  <p>Worm drives</p>	<p>+</p>
<p>22500 Page 545</p>  <p>Worm gears, right-hand centre distance 33 mm</p>	<p>22700-10 Page 562</p>  <p>Worm drives</p>	
<p>22500 Page 547</p>  <p>Worm gears, right-hand centre distance 35 mm</p>	<p>22700-12 Page 563</p>  <p>Worm drive compact</p>	<p>+</p>
<p>22500 Page 549</p>  <p>Worm gears, right-hand centre distance 40 mm</p>	<p>22710 Page 564</p>  <p>Bevel gears plastic housing</p>	
<p>22500 Page 551</p>  <p>Worm gears, right-hand centre distance 50 mm</p>	<p>22712 Page 565</p>  <p>Bevel gears</p>	<p>+</p>
<p>22500 Page 552</p>  <p>Worm gears, right-hand centre distance 53 mm</p>	<p>22714 Page 566</p>  <p>Bevel gears</p>	

+ New/Expanded Items

22000

norelem moves

Systems and components for machine and plant construction











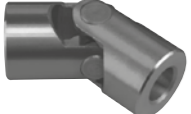









<p>Couplings Rigid couplings Keyless locking couplings Cardan joints Quick-fit couplings Bearings Seals</p> 		<p>23350 Page 590</p>  <p>Keyless locking couplings Form A for thin walled hubs</p>	<p>23360-01 Page 608</p>  <p>Keyless locking couplings Form G stainless steel</p>
<p>23000 Page 571</p>  <p>Metal bellows couplings with radial clamping hub</p>	<p>23022 Page 578</p>  <p>Elastomer dog couplings with radial clamping hub</p>	<p>23350-01 Page 592</p>  <p>Keyless locking couplings Form A stainless steel</p>	<p>23362 Page 611</p>  <p>Keyless locking couplings Form H for high torques</p>
<p>23002 Page 572</p>  <p>Metal bellows couplings clamping with grub screw</p>	<p>23023 Page 579</p>  <p>Elastomer dog couplings clamping with grub screw</p>	<p>23351 Page 594</p>  <p>Keyless locking couplings Form B</p>	<p>23368 Page 613</p>  <p>Keyless locking couplings with central nut</p>
<p>23010 Page 573</p>  <p>Beam couplings with radial clamping hub, aluminium</p>	<p>23030 Page 580</p>  <p>Oldham-type couplings with radial clamping hub</p>	<p>23352 Page 596</p>  <p>Keyless locking couplings Form C with axial ring</p>	<p>23370 Page 614</p>  <p>Shaft-hub clamping sets stainless steel</p>
<p>23012 Page 575</p>  <p>Beam couplings with radial clamping hub, stainless steel</p>	<p>23032 Page 581</p>  <p>Oldham-type couplings clamping with grub screw</p>	<p>23354 Page 598</p>  <p>Keyless locking couplings Form D compact design</p>	<p>23380 Page 617</p>  <p>Shrink discs Form A</p>
<p>23012 Page 575</p>  <p>Beam couplings with removable clamping hub, aluminium</p>	<p>23050 Page 582</p>  <p>Rigid couplings one-piece</p>	<p>23354-01 Page 600</p>  <p>Keyless locking couplings Form D stainless steel</p>	<p>23380-01 Page 619</p>  <p>Shrink discs stainless steel Form A</p>
<p>23012 Page 575</p>  <p>Beam couplings with removable clamping hub, stainless steel</p>	<p>23052 Page 583</p>  <p>Rigid couplings two-piece</p>	<p>23356 Page 603</p>  <p>Keyless locking couplings Form E short version</p>	<p>23382 Page 621</p>  <p>Shrink discs Form B</p>
<p>23021 Page 577</p>  <p>Elastomer dog couplings with conical hub and clamping ring (similar to DIN 69002)</p>	<p>23200 Page 584</p>  <p>Taper clamping bushes</p>	<p>23358 Page 605</p>  <p>Keyless locking couplings Form F short version with axial ring</p>	<p>23403 Page 625</p>  <p>Universal joints double with plain bearing, DIN 808</p>
<p>23021 Page 577</p>  <p>Elastomer dog couplings with conical hub and clamping ring (similar to DIN 69002)</p>	<p>23200 Page 584</p>  <p>Taper clamping bushes</p>	<p>23360 Page 607</p>  <p>Keyless locking couplings Form G stainless steel</p>	<p>23404 Page 626</p>  <p>Universal joints double with plain bearing, DIN 808</p>

+ New/Expanded Items

23000

norelem moves

Systems and components for machine and plant construction

23406 Page 627 	23454 Page 638 	23731 Page 652 	23806 Page 667 
Universal joints single with needle bearing, DIN 808	Quick-fit couplings with angular and radial offset compensation	Plain bearings with collar	Axial angular contact ball bearing, steel double-row +
23407 Page 628 	23500 Page 639 	23732 Page 653 	23806-01 Page 669 
Universal joints double with needle bearing, DIN 808	igubal® pillow block bearings	Thrust washers	Axial angular contact ball bearing, steel double-row, with flange +
23409 Page 629 	23679 Page 640 	23760 Page 654 	23815 Page 670 
Universal joints single with plain bearing, robust version DIN 808	Guide bushes, ceramic +	Plain bearing sintered bronze cylindrical	Spherical roller bearing FAG cylindrical bore
23410 Page 630 	23680 Page 642 	23761 Page 656 	23820 Page 671 
Universal joints double with plain bearing, robust version DIN 808	Guide bushes, bronze, maintenance-free	Plain bearing sintered bronze with collar	Cylinder roller bearing FAG with cage
23412 Page 631 	23681 Page 643 	23800 Page 658 	23825 Page 672 
Cardan shafts telescopic	Guide bushes DIN 9834 / ISO 9448, bronze, maintenance-free with collar	Deep groove ball bearing FAG single row	Tapered roller bearing FAG single row
23414 Page 632 	23682 Page 644 	23800-01 Page 661 	23830 Page 673 
Protective rubber sleeves for universal and cardan joints (single)	Retaining clips DIN 9832	Deep groove ball bearings stainless steel, DIN 626	Axial ball bearing FAG single direction
23415 Page 632 	23710 Page 647 	23800-03 Page 662 	23900 Page 674 
Protective rubber sleeves for universal and cardan joints (double)	Plain bearings plastic	Ceramic ball bearings ZrO2	O-rings
23450 Page 635 	23715 Page 648 	23800-04 Page 663 	23915 Page 681 
Quick-fit couplings with radial offset compensation	Thrust washers plastic	Ceramic ball bearings Si3N4	Rotary shaft lip seals DIN 3760
23452 Page 637 	23730 Page 650 	23805 Page 664 	
Quick-fit couplings with radial offset compensation and mounting flange	Plain bearings cylindrical	Angular contact ball bearing FAG single-row	

+ New/Expanded Items

23000

norelem moves

Systems and components for machine and plant construction

Trapezoidal thread spindles Ball screw linear actuators Bearings units Splined shafts 		24074 Page 703 	24200 Page 716 
24000 Page 686 	24010 Page 694 	Floating bearing units	Pillow block bearing pedestal type UCP
24001 Page 687 	24011 Page 695 	24076 Page 705 	24210 Page 717 
Trapezoidal thread spindles single-start, RH or LH thread	Splined shafts similar to DIN ISO 14	Fixed bearing units block version	Pillow block bearing flange type UCF
24003 Page 689 	24011-01 Page 696 	24078 Page 706 	24212 Page 718 
Trapezoidal thread nuts, round single-start, RH or LH thread	Splined hubs with flange similar to DIN ISO 14	Floating bearing units block version +	Pillow block bearing flange type UCFC with centring hub
24004 Page 690 	24055 Page 699 	24078-01 Page 707 	24215 Page 719 
Trapezoidal thread nuts, round double-start, RH thread	Ball screw linear actuators rolled, with flange nut DIN 69051 Part 5	Fixed bearing units block version +	Pillow block bearing flange type UCFL 2-hole
24005 Page 691 	24060 Page 700 	24078-02 Page 708 	24225 Page 720 
Trapezoidal thread flange nuts single-start, RH or LH thread	Ball screw linear actuators rolled, with screw-in cylinder nut	Floating bearing units block version +	Pillow block bearing pedestal type BPP
24006 Page 692 	24070 Page 701 	24080 Page 709 	24230 Page 721 
Trapezoidal thread nuts with flange double-start, RH thread	Housings for flange nuts	Fixed bearing units flange version	Insert bearing UC
24007 Page 693 	24072 Page 702 	24082 Page 710 	24235 Page 722 
Trapezoidal thread nuts, hexagon single-start, RH or LH thread	Miniature ball screw linear actuators ground, with flange nut	Floating bearing units flange version	Insert bearing B
	24105 Page 714 	24100 Page 712 	24240 Page 723 
	Miniature ball screw linear actuators ground, with screw-in cylinder nut	Pillow block bearing pedestal type MUCP stainless steel	Pillow block bearing pedestal type MUCP stainless steel
	24105 Page 714 	24240-01 Page 724 	24240-01 Page 724 
	Pillow block bearing pedestal type	Pillow block bearing pedestal type	Pillow block bearing pedestal type

+ New/Expanded Items

24000

24241-01
Page 725



Pillow block bearing pedestal type
24242
Page 726



Pillow block bearing flange type MUCF stainless steel
24242-01
Page 727



Pillow block bearing flange type
24244
Page 728



Pillow block bearing flange type MUCF 2-hole stainless steel
24244-01
Page 729



Pillow block bearing flange type 2-hole
24248
Page 730



Insert bearing MUC stainless steel
24262-01
Page 731



Pillow block bearing pedestal type
24264-01
Page 732



Pillow block bearing flange type
24266-01
Page 733



Pillow block bearing flange type 2-hole

Compression springs
Elastomer buffers
Rubber buffers
Shock absorbers
Gas springs



26000
Page 738



Compression springs ISO 10243, light load
26001
Page 740



Compression springs ISO 10243, moderate load
26002
Page 742



Compression springs ISO 10243, heavy load
26003
Page 744



Compression springs ISO 10243, very heavy load
26090
Page 746

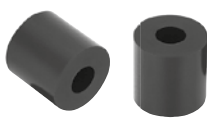

Elastomer buffers Shore 70A
26091
Page 747



Elastomer buffers Shore 80A
26092
Page 748



Elastomer buffers Shore 90A

26100
Page 750



Rubber buffers steel or stainless steel, type A
26101
Page 751



Rubber buffers type AT tapered
26102
Page 751



Rubber buffers steel or stainless steel, type B
26102-01
Page 753



Rubber buffers stainless steel, type B
26103
Page 754



Rubber buffers type E
26103-01
Page 755



Rubber buffers stainless steel, type E
26104
Page 756



Rubber buffers steel or stainless steel, type C

26104-01
Page 757



Rubber buffers stainless steel, type C
26105
Page 758



Rubber buffers type CT tapered
26106
Page 759



Rubber buffers steel or stainless steel, type D
26106-01
Page 760



Rubber buffers stainless steel, type D
26107
Page 761



Rubber buffers type DS suction foot
26108
Page 761



Rubber impact buffers type TP door buffer
26110
Page 762



Rubber buffers parabolic
26112
Page 763



Rubber buffers conical
26115
Page 763



Rubber buffers spherical

26120
Page 764



Rubber-metal impact buffer rails
26130
Page 765



O-shaped mounts
26131
Page 767



Neoprene connecting isolators, two-piece
26150
Page 768



Damping plates
26180
Page 769



Profile dampers axial damping
26182
Page 770



Profile damper axial damping, soft version
26184
Page 771



Profile damper radial damping
26186
Page 772



Profile damper radial damping, hard version
26200
Page 775



Gas springs

26201
Page 777



Gas springs stainless steel
26300
Page 778



Industrial shock absorbers adjustable
26301
Page 779



Industrial shock absorbers adjustable, stainless steel
26320
Page 780



Mounting flange
26320-10
Page 781



Mounting brackets stainless steel
26320-20
Page 782



Stop nuts stainless steel
26330
Page 785



Rotation dampers, steel rotation right, left or both directions

+ New/Expanded Items

+ New/Expanded Items



27810
Page 866
Swivel feet threaded spindles
steel or stainless steel



27811
Page 867
Swivel feet ball joints
with internal thread



27815
Page 869
Levelling feet plates
plastic



27816
Page 870
Levelling feet plates
plastic, heavy-duty version



27817
Page 873
Levelling feet plates
die-cast zinc or stainless steel



27818
Page 874
Levelling feet plates extended
die-cast zinc



27828
Page 875
Levelling feet threaded spindles
steel or stainless steel



27830
Page 877
Levelling feet ECO threaded spindles
die-cast zinc, stainless steel or plastic



27832
Page 878
Levelling feet ECO threaded spindles
steel or stainless steel



27833
Page 879
Ducks feet



27835
Page 880
Tube inserts square
with tapped bush



27836
Page 881
Tube inserts round
with tapped bush



27840
Page 882
Levelling feet
for aluminium profiles



27841
Page 883
Levelling feet



27842
Page 884
Hinges
plastic, lift-off, left



27843
Page 885
Hinges
plastic, lift-off, right



27844
Page 886
Hinges
plastic with fastening holes



27845
Page 887
Hinges
plastic, with locking lever



27846
Page 888
Hinges
aluminium, with detent



27847
Page 889
Hinges
plastic with fastening holes



27848
Page 890
Hinges
plastic, lift-off, with guide tabs



27849
Page 891
Hinges
plastic, detent



27850
Page 892
Hinges
plastic, with adjustable friction



27851
Page 893
Hinges
aluminium, with adjustable friction



27852
Page 894
Hinges
aluminium, with adjustable friction



27853
Page 895
Hinges
aluminium, with adjustable friction



27854
Page 896
Hinges, stainless steel
with preset friction



27855
Page 897
Hinges
aluminium, with detent



27856
Page 898
Hinges
aluminium, with detent



27857
Page 899
Hinges
die-cast zinc, with elongated holes



27858
Page 900
Hinges
die-cast zinc, with locking lever



27859
Page 901
Hinges
aluminium, lift-off, left



27860
Page 902
Hinges
aluminium, lift-off, right



27861
Page 903
Hinges lift-off
stainless steel



27862
Page 904
Hinges
aluminium



27863
Page 905
Hinges
aluminium



27864
Page 906
Hinges
stainless steel



27865
Page 907
Hinges
stainless steel



27866
Page 911
Hinges lift-off
stainless steel



27867
Page 912
Hinges
stainless steel



27868
Page 913
Hinges
stainless steel



27869
Page 914
Single leaf hinges
adjustable, stainless steel



27870
Page 915
Hinges
stainless steel



27871
Page 916
Hinges
stainless steel



27872
Page 917
Strap hinges
stainless steel with grease nipple



27873
Page 918
Hinges
sheet steel or sheet stainless steel



27874
Page 919
Butt hinges
stainless steel



27875
Page 920
Hinges
stainless steel



27876
Page 920
Hinges steel or stainless steel
internal, opening angle 90°



27877
Page 921
Hinges steel or stainless steel
internal, opening angle 125°



27878
Page 922
Hinges steel
internal, opening angle 110°



27879
Page 923
Hinges, steel, in-frame
opening angle 110°



27880
Page 924
Hinges
plastic with bushes



27881
Page 925
Hinges
plastic with fastening screws



27882
Page 926
Hinges
plastic with bush and fastening screws



27883
Page 927
Hinges
weldable



27884
Page 928
Hinges
weldable, stainless steel



27885
Page 929
Hinges
weldable, stainless steel



27886
Page 929
Hinges
weldable, stainless steel



27887
Page 930
In-line hinges stainless steel
lift-off, screw-on

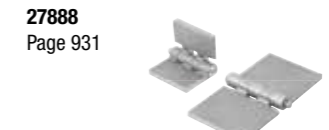

27888
Page 931
Hinges
weldable



27889
Page 932
Block hinges
with fastening nuts



27890
Page 933
Block hinges
with fastening nuts



27891
Page 934
Block hinges
with fastening nuts, long version



27892
Page 935
Block hinges
with counterbore, long version



27893
Page 936
Hinges
steel, maintenance-free



27894
Page 937
Spring hinges
steel, stainless steel or aluminium,
50 mm

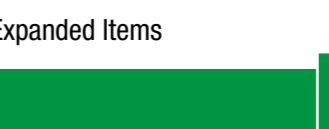

27895
Page 938
Spring hinges
steel, stainless steel or aluminium,
50 mm



27896
Page 938
Spring hinges
steel or stainless steel, 75 mm



27897
Page 939
Spring hinges
steel, stainless steel or aluminium, 120 mm

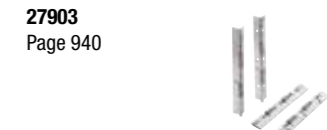

27898
Page 940
Spring hinges
steel or stainless steel, 180 mm



27899
Page 941
Spring hinges
steel or stainless steel, 240 mm



27900
Page 942
Spring hinges
aluminium profile tension spring
hinges, 0.20 Nm



27901
Page 943
Spring hinges
aluminium profile tension spring
hinges, 0.35 Nm

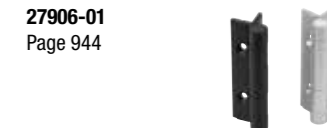

27902
Page 944
Spring hinges
aluminium profile, 0.50 Nm



27903
Page 945
Spring hinges
aluminium profile tension spring
hinges, 0.7 Nm



27904
Page 946
Spring hinges
aluminium profile, 0.7 Nm, long
version



27905
Page 947
Spring hinges
aluminium profile, 0.7 Nm, long
version

+ New/Expanded Items

+ New/Expanded Items

27907-02
Page 947



Spring hinges
aluminium profile, 0.9 Nm,
long version

27908
Page 948



Spring hinges
aluminium profile
tension spring hinges, 1.3 Nm

27909
Page 949



Spring hinges
aluminium profile
tension spring hinges, 3.8 Nm

27950
Page 950



Security hinge switches

27951
Page 951



Security hinge switches
long version

Oil level gauges
Caps
Plugs
Vent screws
Dipsticks
Filler necks



28000
Page 954



Oil level gauges

28000
Page 955



Oil level gauges

28000-10
Page 956



Oil level gauges
with electronic oil level monitoring

28000-11
Page 957



Oil level gauges
with electronic temperature monitoring

28000-12
Page 958



Oil level gauges
with electronic oil level and temperature
monitoring

28001
Page 959



Oil level gauges
long version

28001-10
Page 960



Oil level gauges
with electronic oil level monitoring, long
version

28001-11
Page 961



Oil level gauges
with electronic temperature monitoring,
long version

28001-12
Page 963



Oil level gauges
with electronic oil level and temperature
monitoring, long version

28004
Page 964



Oil level sight glasses

28006
Page 965



Oil level sight glasses
press-in

28008
Page 965



Oil level sight glasses
domed

28010
Page 966



Oil level sight glasses
aluminium

28012
Page 966



Oil level sight glasses
aluminium, glass window

28013
Page 967



Screw plugs with hexagon socket
DIN 906, tapered thread

28014
Page 968



Screw plugs with collar and hexagon
socket
DIN 908

28016
Page 969



Screw plugs hex head with collar
DIN 910

28020
Page 970



Screw plugs

28021
Page 971



Screw plugs
with hexagon socket

28022
Page 972



Press-in plugs

28024
Page 973



Screw plugs with magnet

28026
Page 973



Screw plugs aluminium with magnet

28027
Page 974



Screw plugs
aluminium

28028
Page 975



Screw plugs

28029
Page 976



Screw plugs
with dipstick

28030
Page 977



Plugs fill only
knurled cap

28032
Page 978



Caps for filler necks

28034
Page 978



Vent screws

28036
Page 979



Vent screws
with splash guard

28038
Page 980



Vent screws
with check valve

28040
Page 981



Vent screws brass

28042
Page 981



Vent screws brass
with check valve

28048
Page 982



Press-in plugs
with dipstick

28054
Page 983



Vent screws
with dipstick

28058
Page 984



Vent screws
with check valve and dipstick

28060
Page 985



Dipsticks

28070
Page 986



Filler necks

28071
Page 987



Filler necks

28072
Page 988



Filler necks

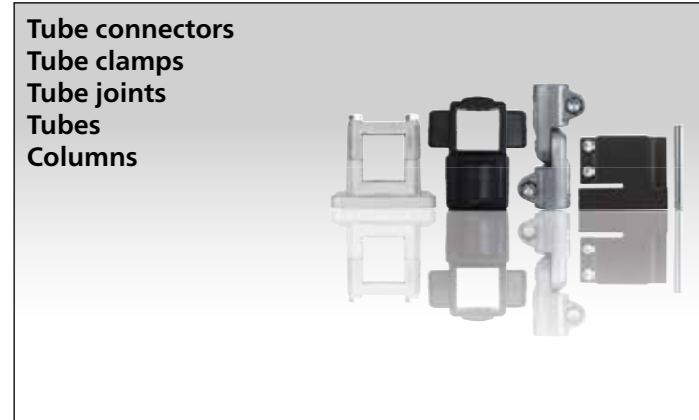

29000
Page 991



Tube clamps cross, plastic

29000
Page 991



Tube clamps cross, aluminium

29000
Page 992



Tube clamps cross, aluminium

29000
Page 993



Tube clamps cross, stainless steel

29002
Page 994



Tube clamps cross, plastic

29002
Page 994



Tube clamps cross, aluminium

29004
Page 995



Tube clamps cross, plastic

29004
Page 995



Tube clamps cross, aluminium

29006
Page 996



Tube clamps T-angle, plastic

29006
Page 997



Tube clamps T-angle, aluminium

29006
Page 998



Tube clamps T-angle, stainless steel

29008
Page 999



Tube clamps T-angle, plastic

29008
Page 1000



Tube clamps T-angle, aluminium

29008
Page 1000



Tube clamps right-angle, aluminium

29010
Page 1001



Tube clamps base, plastic

29010
Page 1002



Tube clamps base, aluminium

29010
Page 1003



Tube clamps base, stainless steel

29012
Page 1004



Tube clamps base, plastic

29012
Page 1004



Tube clamps base, aluminium

29014
Page 1005



Tube clamps flange, plastic

29014
Page 1006



Tube clamps flange, aluminium

29014
Page 1007



Tube clamps flange, aluminium

29014
Page 1008



Tube clamps flange, stainless steel

29016
Page 1009



Tube clamps flange, plastic

29016
Page 1009



Tube clamps flange, aluminium

29022
Page 1010



Tube clamps straight, plastic

29024
Page 1011



Tube clamps swivel half, sunken teeth, plastic

29026
Page 1012



Tube clamps swivel half, raised teeth, plastic

29028
Page 1013



Tube clamps swivel half, sunken teeth, plastic

29030
Page 1014



Tube clamps swivel base, sunken teeth, plastic

29032
Page 1015



Tube clamps swivel, plastic

29032
Page 1016



Tube clamps swivel, aluminium

29000



29034
Page 1017

Tube clamps swivel, plastic

29034
Page 1018



Tube clamps swivel, aluminium

29036
Page 1019



Tube clamps swivel base, plastic

29036
Page 1020



Tube clamps swivel base, aluminium

29040
Page 1021



Reducer sleeves square

29042
Page 1021



Reducer sleeves round

29050
Page 1022



Round and square tubes

29056
Page 1023



Tube end plugs

29105
Page 1025



Linear actuators

29105
Page 1026



Linear actuators, stainless steel

29120
Page 1027



Linear actuator connector clamps cross

29120
Page 1028



Linear actuator connector clamps, stainless steel cross

29125
Page 1029



Linear actuator connector clamps cross

29130
Page 1030



Linear actuator connector clamps flange

29130
Page 1031



Linear actuator connector clamps, stainless steel flange

29135
Page 1032



Linear actuator connector clamps base

29135
Page 1033



Linear actuator connector clamps, stainless steel base

29180
Page 1036



Monitor brackets

29200
Page 1042



Column bases single

29205
Page 1043



Column bases double

29207
Page 1044



Column clamps double

29210
Page 1045



Adjustment units

29215
Page 1046



Column shaft collars

29240
Page 1047



Rods stainless steel

29000

+ New/Expanded Items

+ New/Expanded Items

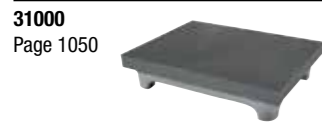

31130
Page 1053

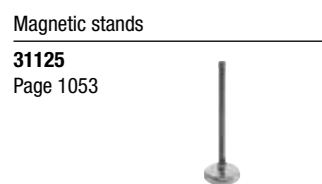
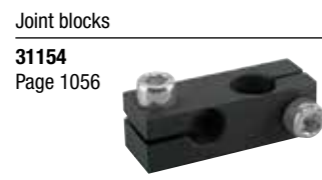
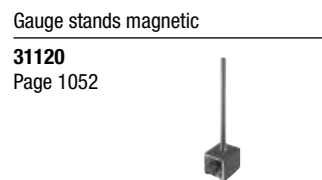
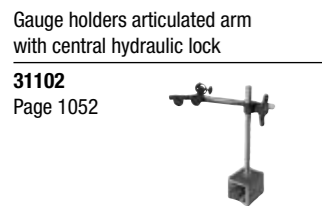
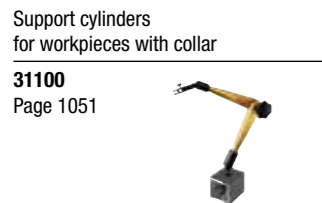
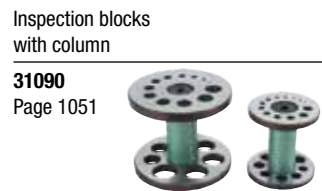
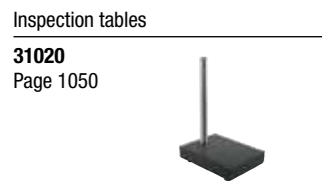

Magnetic stands

Clamping joints

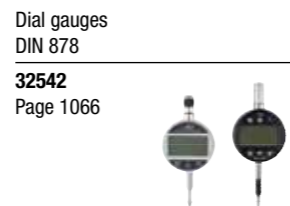
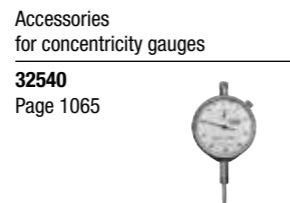
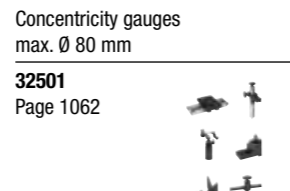
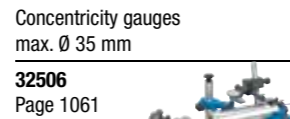
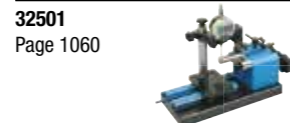

Dial gauges digital

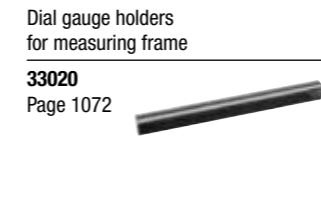
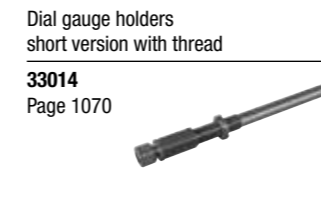
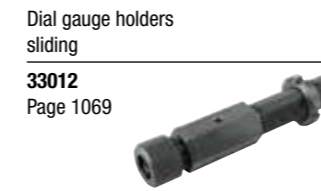
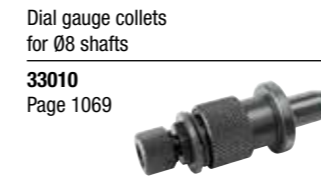

Probe with flat face

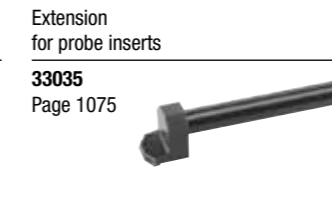
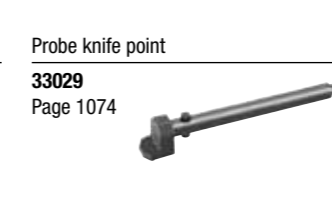
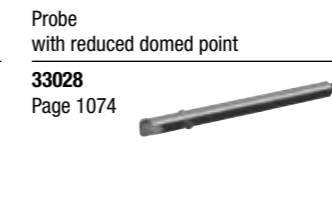
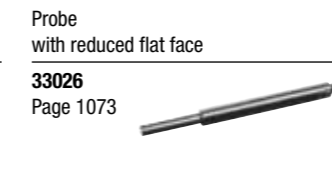
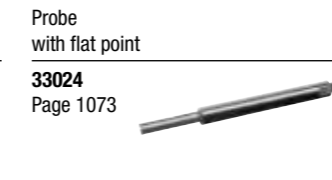

Probe knife point offset, for fixed stop



Probe inserts with domed point

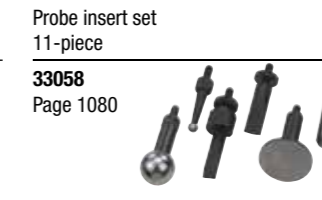
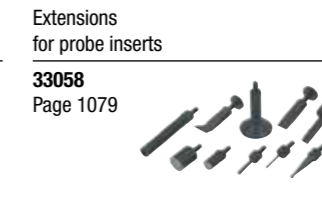
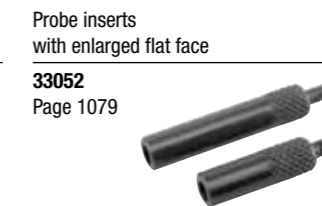
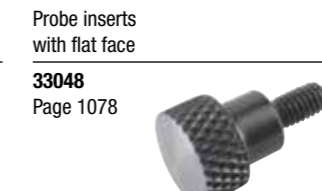
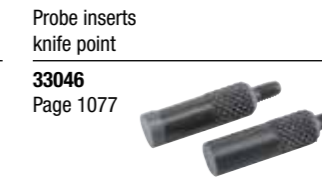

Probe inserts hardened steel thread M2.5



Probe inserts carbide thread M2.5

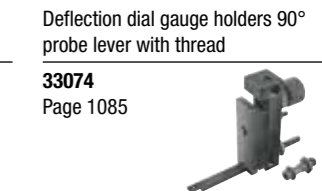
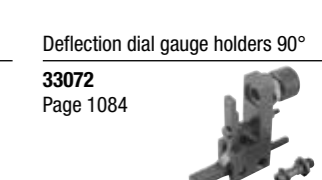
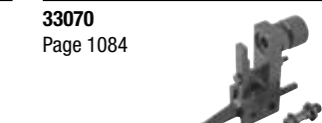
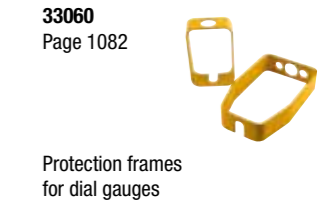

Prism attachments

+ New/Expanded Items

+ New/Expanded Items

norelem measures

Measuring and testing components



33092
Page 1087

Spacers
for prisms attachments



33105
Page 1088

Slotted round nuts



33110
Page 1089

Pivoting columns

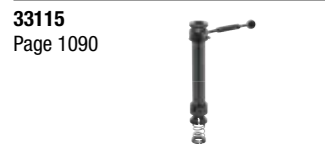

33115
Page 1090

Pivoting systems



33140
Page 1091

Measuring fixtures



33150
Page 1093

Measuring arms



33180
Page 1094

Spring mounted centre sleeves
with tension lever

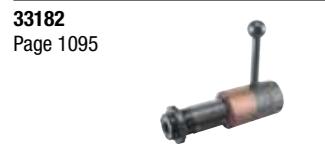

33182
Page 1095

Precision three-jaw chuck
manual operation



33184
Page 1096

Adjustable holder
for fixed centres



33190
Page 1096



33190
Page 1096

Fixed centres



33202
Page 1098

Measuring element
for gear wheels



33205
Page 1099

Ball holders



33225
Page 1101

Precision vice



33225-10
Page 1102

Precision vices
stainless steel, aluminium or brass,
mini **+**



33225-15
Page 1103

Stainless steel jaw plates
for precision vices **+**



33225-16
Page 1104

Mounting plates aluminium
for precision vices **+**

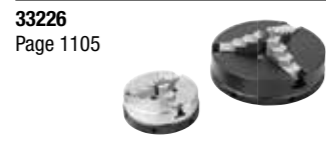

33226
Page 1105

Precision three-jaw chuck
manual operation



33227
Page 1106

Needle support

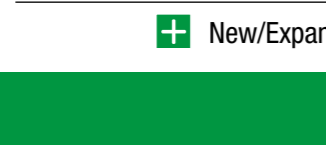

33260
Page 1107



33260
Page 1107

Spring fingers



33262
Page 1108

Columns
for spring fingers



33262
Page 1108

33000

norelem measures

Clamping technology

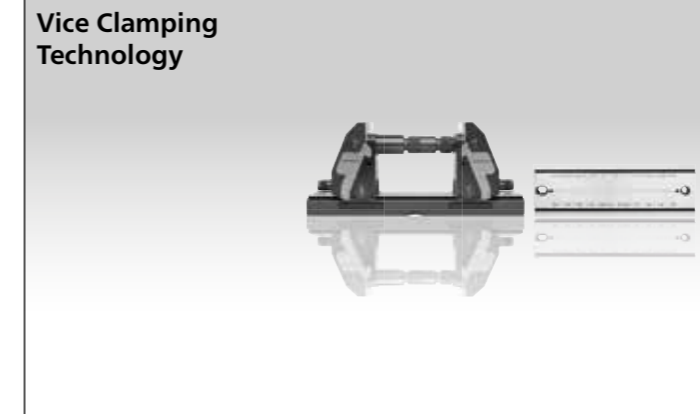

41300
Page 1114

5-axis clamping system compact
jaw plate, smooth



41305
Page 1115

Base plates



41315
Page 1116

Vice jaws complete



41320
Page 1117

Jaw plates smooth



41320
Page 1117

Jaw plates with pins



41320
Page 1118

Jaw plates
machinable



41325
Page 1119

Pendulum jaws



41330
Page 1120



41330
Page 1120

Jaw plates smooth
for pendulum jaws



41330
Page 1121

Jaw plates with pins
for pendulum jaws



41335
Page 1122

Centre jaws



41340
Page 1123

Jaw plates smooth
for centre jaws



41340
Page 1123

Jaw plates with pins
for centre jaws



41345
Page 1124

Seating ledges

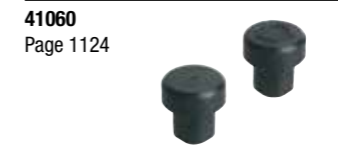

41060
Page 1124

Jaw pins



41350
Page 1125



41350
Page 1125

Cylinder clamping sets



41355
Page 1126

Extension shafts



41360
Page 1126

Adapter shafts



41365
Page 1127

Couplings
for cross-clamping



41370
Page 1128

Stop sets



41375
Page 1129

Clamping claw sets

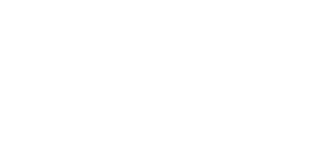

41375
Page 1129

+ New/Expanded Items

+ New/Expanded Items

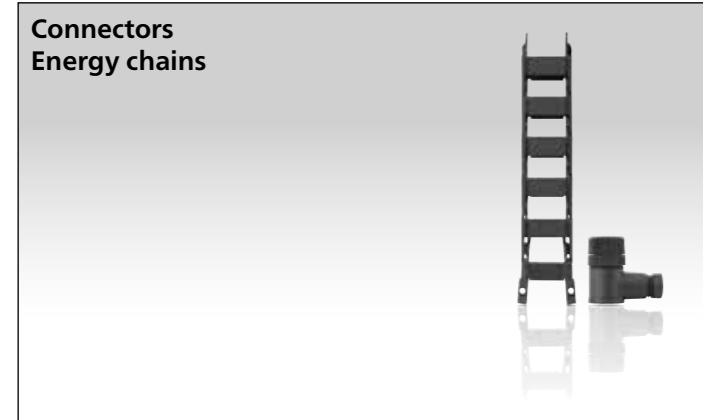

80100
Page 1132



80150
Page 1133



80150-10
Page 1134



80850
Page 1135



80850-01
Page 1136



80850-10
Page 1137



80850-11
Page 1138



80850-12
Page 1139



80850-20
Page 1140



80850-21
Page 1141



80850-22
Page 1142



80850-23
Page 1142



80850-30
Page 1143



80850-31
Page 1144



80850-32
Page 1145



80850-33
Page 1145



80850-90
Page 1146



80850-91
Page 1147



80850-92
Page 1148



80850-93
Page 1148

80000

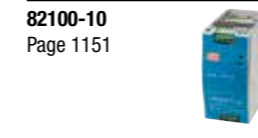
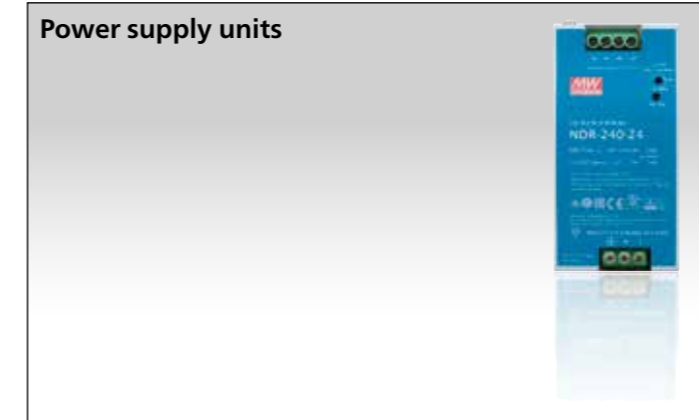

82100-10
Page 1151

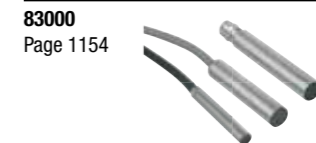
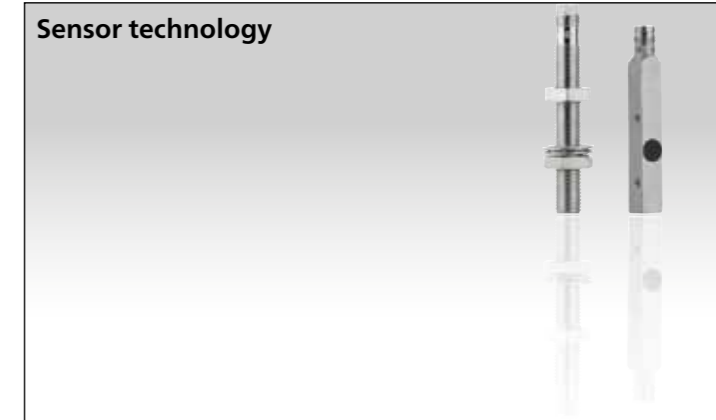

83000
Page 1154



83000-05
Page 1155



83000-10
Page 1156

82000 / 83000

+ New/Expanded Items

+ New/Expanded Items

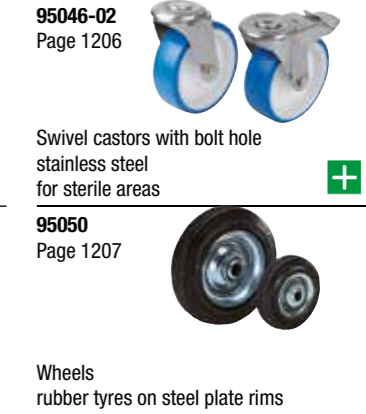
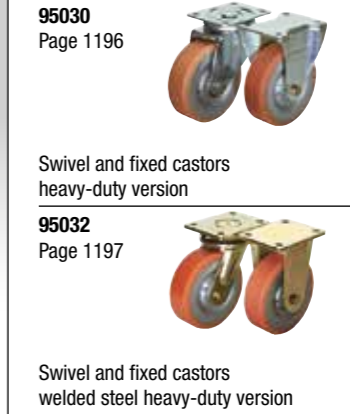

84100
Page 1158

Cable screw connections plastic **+**

84100-05
Page 1159

Cable screw connections nickel-plated brass **+**

84100-10
Page 1160

Cable screw connections stainless steel **+**

84100-13
Page 1161

Cable fasteners stainless steel or plastic in Hygienic DESIGN **+**

84100-15
Page 1162

Cable screw connections EMC nickel-plated brass **+**

84100-20
Page 1163

Cable screw connections EMC stainless steel **+**

84100-30
Page 1164

Hexagon nuts for cable screw connections **+**

84100-32
Page 1165

Hexagon nuts for cable screw connections EMC **+**

84100-50
Page 1166

Screw plugs plastic, round **+**

84100-51
Page 1167

Screw plugs brass, round **+**

85000
Page 1170

Stepper motor

85000-10
Page 1175

Stepper motors with integrated positioning control

85000-15
Page 1176

Accessories for stepper motors with integrated positioning control **+**

85300
Page 1177

Lifting columns aluminium electrically adjustable **+**

85300-10
Page 1178

Controls for lifting columns **+**

85300-15
Page 1179

Hand switch for lifting columns **+**

95010
Page 1182

Swivel and fixed castors standard version

95010
Page 1183

Swivel and fixed castors electrically conductive, standard version

95012
Page 1184

Swivel and fixed castors heavy-duty version

95012
Page 1185

Swivel and fixed castors steel plate, electrically conductive, heavy-duty version

95016
Page 1186

Swivel and fixed castors standard version

95016
Page 1187

Swivel and fixed castors steel plate, electrically conductive standard version

95018
Page 1188

Swivel and fixed castors standard version

95020
Page 1189

Swivel and fixed castors heavy-duty version

95024
Page 1190

Swivel and fixed castors medium-duty version **+**

95025-01
Page 1192

Swivel and fixed castors steel plate, heavy-duty version **+**

95026
Page 1193

Swivel and fixed castors steel plate, with soft rubber tyres **+**

95026-01
Page 1194

Swivel castors, steel plate with soft rubber tyres and bolt hole **+**

95028
Page 1195

Swivel and fixed castors medium-duty version

95030
Page 1196

Swivel and fixed castors welded steel heavy-duty version

95034
Page 1198

Swivel and fixed castors standard version

95036
Page 1199

Swivel and fixed castors heavy-duty version

95040
Page 1200

Swivel and fixed castors stainless steel, standard version **+**

95041
Page 1201

Swivel castors compact version

95045
Page 1203

Swivel and fixed castors steel plate, for sterile areas **+**

95046
Page 1204

Swivel and fixed castors stainless steel for sterile areas **+**

95046-02
Page 1206

Wheels rubber tyres on steel plate rims

95050
Page 1207

Wheels rubber tyres on die-cast aluminium rims

95053
Page 1208

Wheels polyamide with injection-moulded tread

95057
Page 1209

Guide rollers

95058
Page 1210

Wheels aluminium rims with injection-moulded tread

95059
Page 1210

Rollers heavy-load

95060
Page 1211

Wheels heavy-load wheel body welded

95062
Page 1211

Wheels polyamide

+ New/Expanded Items

+ New/Expanded Items

95064
Page 1212



Wheels polyamide heavy-duty version

95065
Page 1213



Thermostat wheels heat-resistant

95090
Page 1214



Elevating castors with foot with bolt hole or mounting plate

95092
Page 1215



Elevating castors with integrated machine foot

95150
Page 1217



Ball transfer units with steel housing

95152
Page 1218



Ball transfer units with steel housing and plastic ball

95154
Page 1219



Ball transfer units undersprung

95156
Page 1220



Ball transfer units with solid steel housing

95156-01
Page 1220



Ball transfer units heavy duty stainless steel

95156-02
Page 1221



Ball transfer units heavy duty stainless steel, suitable for outdoor use

95158
Page 1221



Ball transfer units with fastening holes, without housing

95160
Page 1222



Ball transfer units with spring clips

95164
Page 1222



Tolerance rings

95180
Page 1223



Ball transfer units mini

95182-01
Page 1224



Ball transfer units with stud stainless steel

95300
Page 1225



Small conveyor belts with internal drive

Coolant hoses
Feeler gauge strips
Magnetic labels and envelopes
Protective nets
Supercraft mallets and inserts
Taper and cylinder cleaners

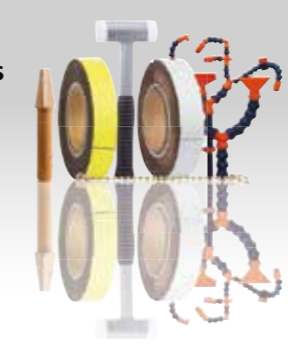

96200
Page 1229



Coolant hose LOC-LINE® Flexi

96202
Page 1232



Suction hoses LOC-LINE® Flexi 75 antistatic

96205
Page 1234



High pressure nozzles LOC-LINE®

96382
Page 1235



Feeler gauge strips

96390
Page 1236



Ball chains

96450
Page 1238



Magnetic labels on a roll, perforated

96455
Page 1238



Magnetic C profiles

96470
Page 1240



Magnetic envelopes

96471
Page 1240



Magnetic envelopes with strong magnetics

96500-01
Page 1242



Plastic protective net caps

96455
Page 1238



Magnetic tape rolls

96460
Page 1239



Magnetic C profiles

96470
Page 1240



Magnetic envelopes

96471
Page 1240



Magnetic envelopes with strong magnetics

96500-01
Page 1242



Plastic protective net caps

96510
Page 1243



Net mats

96512
Page 1244



Plastic separators for Euro containers

96520
Page 1246



Edge protection profiles with steel retaining strip

96521
Page 1247



Edge protection profiles with integrated steel wire core

96610
Page 1248



Supercraft soft faced hammer recoilless

96614
Page 1248



Hammer inserts for Supercraft hammers

96630
Page 1249



Taper cleaners for Morse tapers

96632
Page 1249

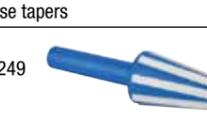

Taper cleaners for short tapers

96634
Page 1250



Taper cleaners for hollow shank tapers

96650
Page 1252



Hook wrench with lug DIN 1810A enhanced

96651
Page 1253



Face pin spanner adjustable, cranked

96662-01
Page 1254



Torque wrench for 5-axis clamping system

96990
Page 1255



Free-standing floor version

96990
Page 1256

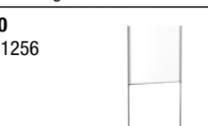

Screwed-down floor version

96990
Page 1257



Floor version on rollers

96990
Page 1258



Free-standing counter version

96990
Page 1259

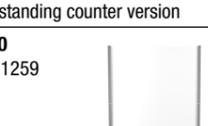

Screwed-down counter version

96990
Page 1260

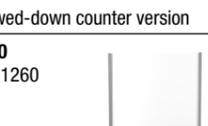

Front mounted counter version

+ New/Expanded Items

+ New/Expanded Items

96990-10
Page 1261



Acrylic glass panels

96990-12
Page 1262



Basic modules

96990-13
Page 1263



Round bars

96990-15
Page 1264



HYGIENeshield Premium



Lubricants
Adhesives
Grease nipples

97900
Page 1266



Klüber "Quietsch-Ex"

97901
Page 1266



Klüber lubricating paste

97903
Page 1267



Klüber copper paste
lead-free

97905
Page 1267



Klüber safety lubricating grease

97907
Page 1268



Klüber molybdenum disulphide lubricant

97907-10
Page 1269



Lubricating greases

97920
Page 1270



Klüber bonded coating
UNIMOLY C 220

97930
Page 1271



Ballistol all-purpose oil
in food industry quality

97940
Page 1272



Grease nipples
conical head DIN 71412

97941
Page 1274



Grease nipple caps
for conical grease nipples

97942
Page 1275



Grease nipples
flush type, DIN 3405

97944
Page 1276



Grease nipples
button head DIN 3404

97950
Page 1277



Grease nipple assortment box, steel

97990
Page 1278



LOCTITE liquid epoxy metals

97990
Page 1278



LOCTITE liquid epoxy metals

97990
Page 1279



LOCTITE threadlocker

97990
Page 1280



LOCTITE universal adhesive

97990
Page 1281



LOCTITE thread sealant

97990
Page 1282



LOCTITE flange sealant

97990
Page 1283



LOCTITE adhesive and sealant

97990
Page 1284



LOCTITE retaining compound

97990
Page 1285



LOCTITE cleaner

97990
Page 1286



LOCTITE activators

97990
Page 1286



Application equipment

97990-10
Page 1287



Push-type grease guns

97990-11
Page 1288



DIN 1283 grease guns

97990-12
Page 1289



Grease guns, one-hand operation,
similar to DIN 1283

97990-13
Page 1290



Grease guns, two-hand operation

97990-15
Page 1291



Grease gun mouthpieces, steel

97990-16
Page 1292



Reinforced hoses for DIN 1283
grease guns

97990-30
Page 1293



Pump spray bottles



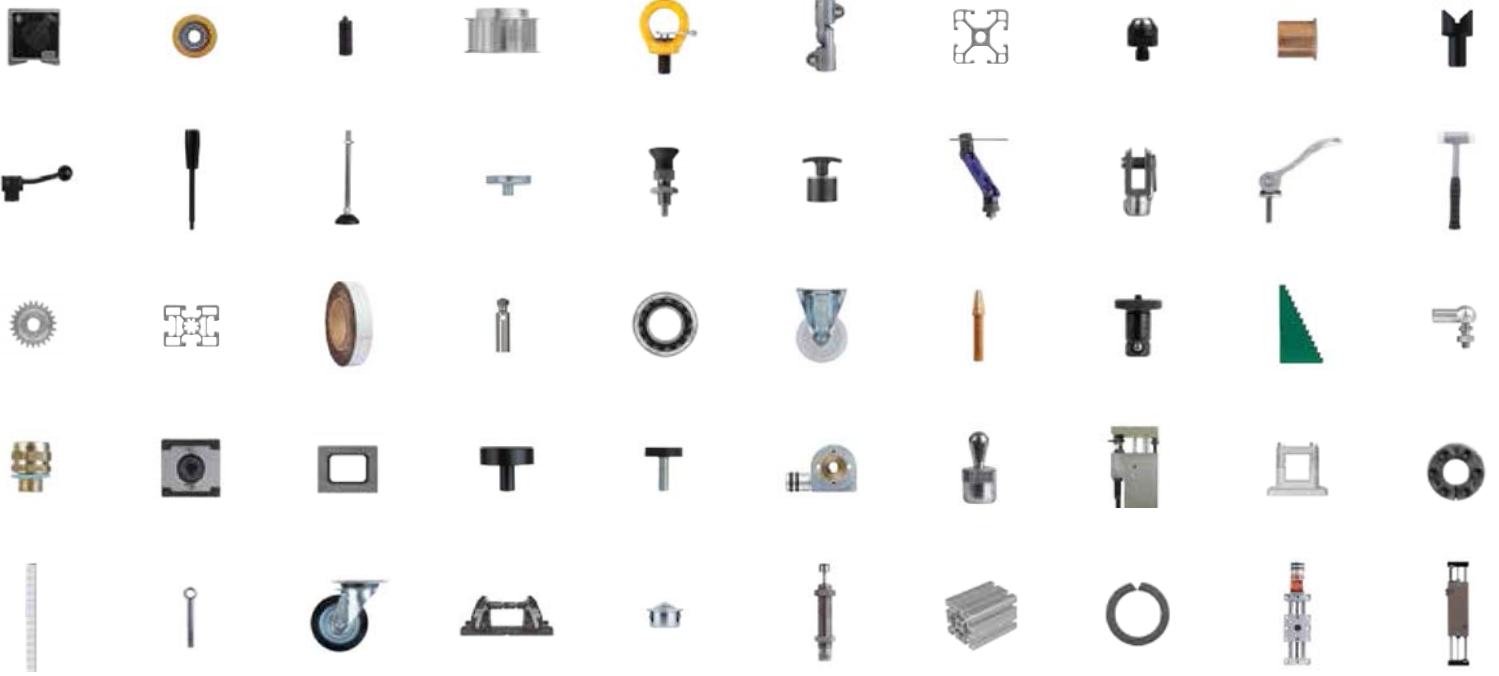

WE10ENPR2204